



PRODUCT INFORMATION



Progettiamo e realizziamo complementi d'arredo che aiutano a semplificare la vita quotidiana: oggetti funzionali caratterizzati da un elevato design.

We design and manufacture furnishing accessories which help make your life easier: highly functional objects with top class design.

Nous concevons et réalisons des compléments d'ameublement qui aident à simplifier la vie quotidienne: des objets fonctionnels, caractérisés par un design exceptionnel.

KITCHEN&LIVING

SC SOUS-CHEF

organizzatori di spazio per dispensa / internal kitchen space organizers

04

P PREMIÈRE

<input type="checkbox"/>	separate waste collection system	10
	cutlery trays	12
○	tableware racks	14
┌	storage system	16

V BIN IT

	raccoglitori grande capacità / large capacity waste bins	18
	raccoglitori ad estrazione frontale / pull-out waste bins	36
	raccoglitori per cestone / large drawer waste bins	46
	raccoglitori da anta / door mounted waste bins	54
	raccoglitori multiuso / multi-function bins	56

F TIDY IT

	portaposate Linea COMBI™ / COMBI™ Line cutlery trays	58
	portaposate Linea Classica / Classic Line cutlery trays	62
	portaposate Linea Design / Design Line cutlery trays	64
	portaposate Linea Legno / Wood Line cutlery trays	68

BATHROOM&LAUNDRY

onda ONDA

	ONDA Vanity™ accessori per cassetto / drawer accessories	72
	accessori per cestone / large drawer accessories	79
	accessori per anta / door mounted accessories	81

WHITES & COLOURS

laundry system

82

KITCHEN&LIVING





NEW



Sous-Chef

Sous-Chef è un'innovativa soluzione per la cucina studiata per rispondere in maniera intelligente all'esigenza di organizzare al meglio anche gli spazi ridotti. Dotato di vaschette removibili e posizionabili sul top della cucina, Sous-Chef permette di avere a portata di mano tutti gli ingredienti e gli accessori di uso quotidiano. A fine uso le vaschette sono riposizionabili nel mobile agganciandole alla struttura centrale. Sous-Chef è dotato anche di un pratico portacoltelli in finitura noce disponibile come optional. Grazie ai vari modelli della gamma si possono attrezzare mobili con basi da 150 a 600 mm. Il prodotto è adatto sia a mobili con anta battente che alle più comuni tipologie di cassetto (Blum®, Grass®, Hettich®, FGV®...).

Sous-Chef is the latest innovative solution from Gollinucci designed to organize internal kitchen spaces. Equipped with adjustable compartments, the product allows for easy access for all cooking ingredients, accessories and cutlery. The product is also available with a knife holder (in walnut finish), and can be used in cabinets from 150mm-600mm. The product is suitable both for cabinets with standard doors and for the most common types of drawer (Blum®, Grass®, Hettich®, FGV®...).

Sous-Chef est une solution innovante qui répond de façon simple à la nécessité de mieux organiser les plus petits espaces dans la cuisine. Doté de boîtes amovibles qui peuvent être posées sur le plan de travail, Sous-Chef vous permet à tout moment d'avoir à portée de main les ingrédients et accessoires à usage quotidien. En fin d'utilisation, les boîtes peuvent être repositionnées dans le meuble en les accrochant à la structure centrale. Sous-Chef peut être également équipé en option d'un porte couteaux en bois, très pratique, disponible dans la finition noyer. Grâce aux différents modèles de la gamme, il est possible d'équiper des meubles de largeur 150 à 600 mm. Selon le modèle, Sous-Chef peut être monté dans un meuble à portes battantes ou dans les tiroirs standard les plus courants (type Blum®, Grass®, Hettich®, FGV® etc...).



Sous-Chef

Proposte di utilizzo
Set-up suggestions
Exemples d'emploi

base 600_500_450 mm

Mobile con cestone
Cabinet with drawer
Meuble avec grand tiroir

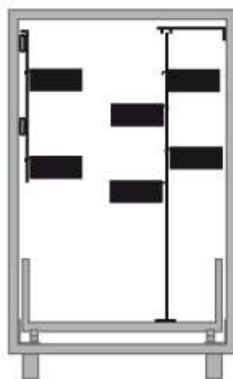

Sous-Chef Smart(pag.9) + ***Sous-Chef One**(pag.7)

Mobile con anta battente
Standard cabinet
Meuble avec porte battante

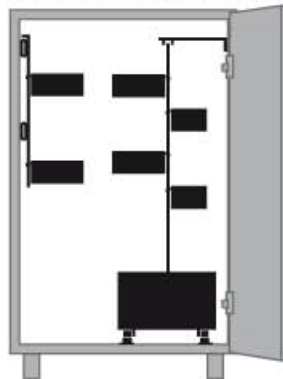

Sous-Chef Smart(pag.9) + **Sous-Chef Tray**(pag.7)

base 200 mm

Mobile con anta battente
Standard cabinet
Meuble avec porte battante

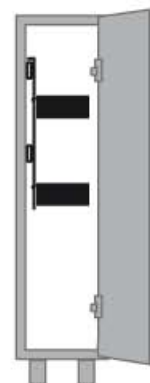

Sous-Chef Smart(pag.9)

base 400_350_300 mm

Mobile con cestone
Cabinet with drawer
Meuble avec grand tiroir

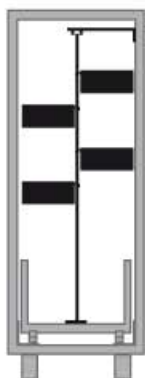

***Sous-Chef One**(pag.7)

Mobile con anta battente
Standard cabinet
Meuble avec porte battante

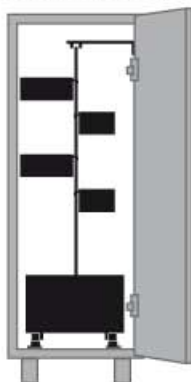

Sous-Chef Tray(pag.7)

Fissaggio all'anta
Door mounting
Fixation sur porte

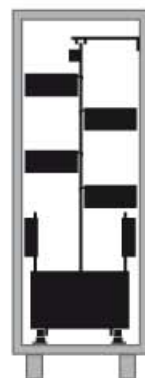

Sous-Chef Tray Plus(pag.8)

base 150 mm

Fissaggio all'anta
Door mounting
Fixation sur porte



Sous-Chef Slim(pag.8)

Disponibili per mobili profondità 50 (personalizzabili, su richiesta, per profondità 45)
Available for depth 50 cabinets (customizable, on request, for depth 45)
Disponible pour meubles profondeur 50 (personnalisable, sur demande, pour profondeur 45)

*Adatto alle più comuni tipologie di cassetto (Blum®, Grass®, Hettich®, FGV®...). Cassetto non incluso.
*Suitable for the most common types of drawer (Blum®, Grass®, Hettich®, FGV®...). Drawer not included.
*Adapte pour les tiroirs standard les plus courants (type Blum®, Grass®, Hettich®, FGV® etc...). Tiroir pas inclus.

Sous-Chef

Colori/Colours/Couleurs:
Grigio orione/Orion grey/Gris orion

Sous-Chef One



- **Fissaggio al fondo del cassetto**
- Struttura in metallo
- Vaschette removibili in plastica
- **Fixing to the bottom of the drawer**
- Metal frame
- Removable plastic trays
- **Fixation sur fond du tiroir**
- Structure en metal
- Petites vasques amovibles

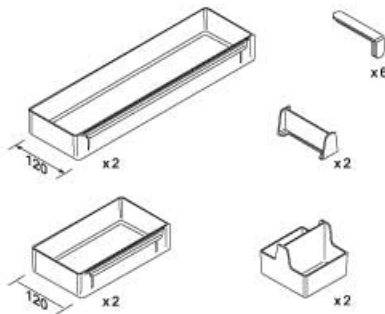

(Cassetto non incluso)
(Drawer not included)
(Tiroir pas inclus)

W. 255
D. 516
H. 641



Optional
En option
(pag. 9):

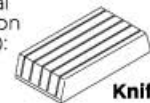

Knife Block

Sous-Chef Tray



- **Fissaggio al fondo del mobile**
- Guide ad estrazione totale
- Chiusura assistita e ammortizzata
- Estrazione manuale
- Struttura in metallo
- Vaschette removibili in plastica
- **Fixing to the bottom of the cabinet**
- Full extension slides
- Soft closing
- Manual extraction
- Metal frame
- Removable plastic trays
- **Fixation sur fond du meuble**
- Glissières à sortie totale
- Fermeture assistée et amortie
- Extraction manuelle
- Structure en metal
- Petites vasques amovibles

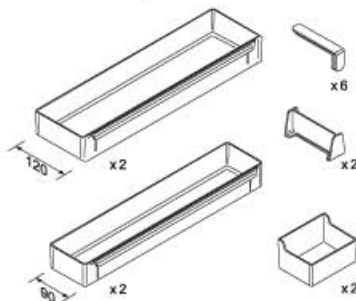

Optional
En option
(pag. 9):

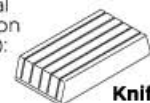

Knife Block

W. 255
D. 516
H. 654



WITH
TRAY



Sous-Chef Tray Plus

- **Fissaggio al fondo del mobile**
 - **Fissaggio all'anta**
 - Guide ad estrazione totale
 - Chiusura assistita e ammortizzata
 - Struttura in metallo
 - Vaschette removibili in plastica
- **Fixing to the bottom of the cabinet**
 - **Door mounting**
 - Full extension slides
 - Soft closing
 - Metal frame
 - Removable plastic trays
- **Fixation sur fond du meuble**
 - **Fixation sur porte**
 - Glissières à sortie totale
 - Fermeture assistée et amortie
 - Structure en metal
 - Petites vasques amovibles



WITH TRAY

W. 255
D. 520
H. 654



10 min



min 300 mm

Optional
En option
(pag. 9):

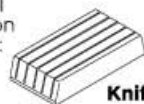

Knife Block

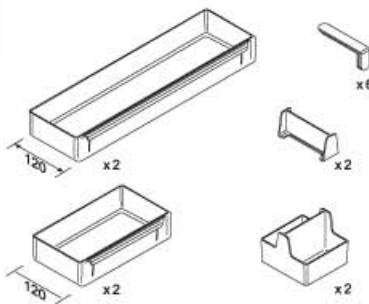

Sous-Chef Slim

- **Fissaggio al lato del mobile**
 - **Fissaggio all'anta**
 - Guide ad estrazione totale
 - Chiusura assistita e ammortizzata
 - Struttura in metallo
 - Vaschette removibili in plastica
- **Fixing to the side of the cabinet**
 - **Door mounting**
 - Full extension slides
 - Soft closing
 - Metal frame
 - Removable plastic trays
- **Fixation sur le côté du meuble**
 - **Fixation sur porte**
 - Glissières à sortie totale
 - Fermeture assistée et amortie
 - Structure en metal
 - Petites vasques amovibles



W. 108
D. 506
H. 680



10 min



150 mm

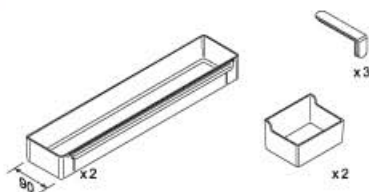

Sous-Chef

Sous-Chef Smart



- **Fissaggio al lato del mobile**
- Guide ad estrazione totale
- Chiusura assistita e ammortizzata
- Struttura in metallo
- Vaschette removibili in plastica
- Estrazione manuale
- **Fixing to the side of the cabinet**
- Full extension slides
- Soft closing
- Metal frame
- Removable plastic trays
- Manual extraction
- **Fixation sur le côté du meuble**
- Glissières à sortie totale
- Fermeture assistée et amortie
- Structure en métal
- Petites vasques amovibles
- Extraction manuelle



W. 138
D. 506
H. 334



10 min



min 200 mm

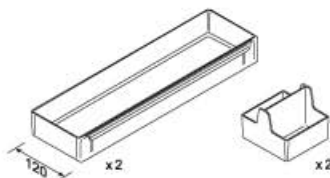

Optional
En option:

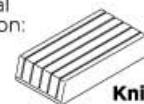

Knife Block

Optional Sous-Chef

Sous-Chef Knife Block

WOOD



Porta coltelli in legno
Finitura in noce
Adatto ad art.
**Sous-Chef One, Sous-Chef Tray,
Sous-Chef Tray+, Sous-Chef Smart.**

Wooden knife block
Walnut finish
Suitable for item:
**Sous-Chef One, Sous-Chef Tray,
Sous-Chef Tray+, Sous-Chef Smart.**

Porte-couteaux en bois
Finition noyer
Indiqué pour les réf.
**Sous-Chef One, Sous-Chef Tray,
Sous-Chef Tray+, Sous-Chef Smart.**





L'anello ferma il sacchetto e lo mantiene nascosto all'interno
The ring holds the bin bag in position and hides it completely at the inside
La bague bloque le sachet et le cache complètement à l'intérieur



Coperchio incernierato con semplice sistema aggancio/sgancio
Hinged lid with functional device for easy hooking/unhooking
Couvercle doté de charnière et simple système d'accrochage/décrochage



Contenitore porta-detergenti con robusto manico facile da trasportare
Container for detergents with sturdy handle for easy carrying
Conteneur porte-détergents avec robuste poignée facile à transporter



Contenitore per carta/porta-riviste
Paper collector/magazine-holder
Collecteur pour papier/porte-revues



Disponibile su richiesta: il vassoio scorre su base in acciaio inox satinato. Adatto a cassetti con profondità maggiori (fino a 575mm)

Available on demand: the tray slides on a satin stainless steel. Suitable for drawers with greater depths (up to 575mm)
Disponibile sur demande: le plateau glisse sur une base en acier inox satiné. Disponible pour des tiroirs avec des profondeurs supérieures. (jusqu'à 575mm)

separate waste collection system

Colori/Colours/Couleurs:
Bianco/White/Blanc
Grigio orione/Orion grey/Gris orion



base 1200 mm

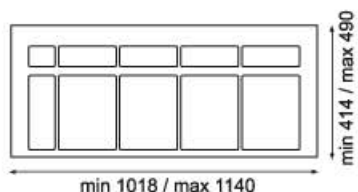

Art.
1038*
1049
1032*
1051

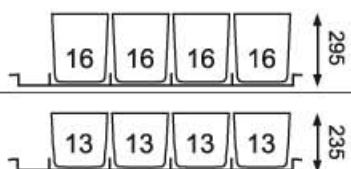

base 900 mm

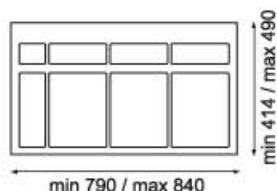

Art.
1034*
1045
1030*
1047

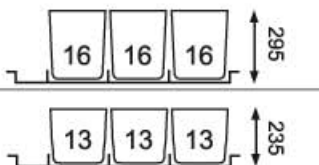

base 600 mm

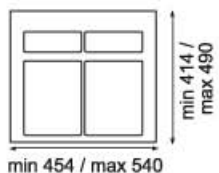

Art.
1036*
1043
1029*
1044

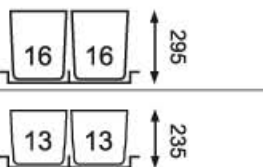

*Coperchi rivestiti in acciaio inox satinato / Lids with satin stainless steel coatings / Couvertres avec revêtement en acier inox satiné

accessori/accessories/accessoires

Kit PRPRE



Optional (base900, base1200)
Contenitore per carta
Paper collector
Collecteur pour papier



Kit PDET



Optional
Vaschetta scorrevole acciaio
inox e separatori
posizionabili sul fondo
Sliding satin stainless
steel tray and dividers to be
positioned on the bottom
Bac coulissant en acier inox
et séparateurs à loger sur le
fond



Prodotti abbinabili con elemento in alluminio per **cestone sottolavello**
Products can be combined with aluminium element for **under-sink drawer**
Produits combinables avec élément en aluminium pour **tiroir sous-évier**

NEW
Art. 955
PAG.56





Colori/Colours/Couleurs:
Bianco/White/Blanc
Grigio orione/Orion grey/Gris orion

1140

base 1200 mm

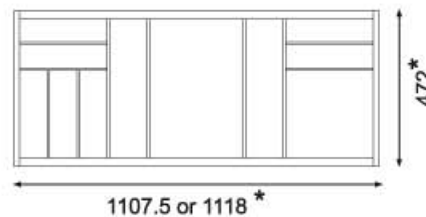

1130

base 900 mm

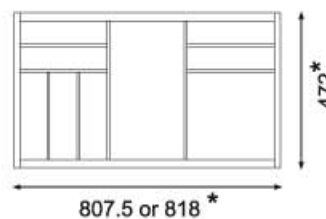
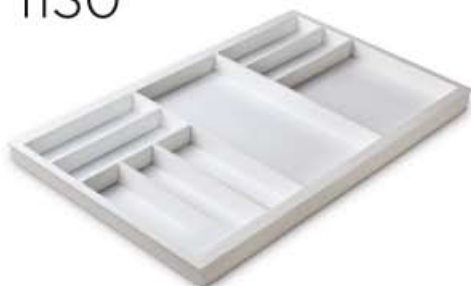

1120

base 600 mm

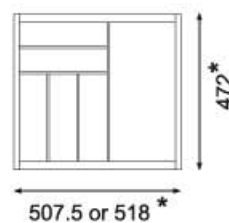

1115

base 450 mm

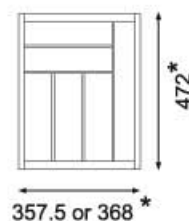

* Disponibili per cassetti Blum®, Grass®, Hettich®, FGV®
Available for drawers: Blum®, Grass®, Hettich®, FGV®
Disponibles pour tiroirs: Blum®, Grass®, Hettich®, FGV®

accessori/accessories/accessoires



Colori/Colours/Couleurs:
Bianco/White/Blanc
Grigio orione/Orion grey/Gris orion

1151

Inserto divisorio in legno a 3 vani. Adatto ad art. **1140, 1130**
3 compartments wood divider. Suitable for item: **1140, 1130**
Separateur en bois à 3 sections. Indiqué pour les réf. **1140, 1130**



1153

Coppia di taglieri in legno. Adatto ad art. **1140, 1130**
Pair of wooden chopping boards. Suitable for item: **1140, 1130**
Paire de planches à découper en bois. Indiqué pour les réf. **1140, 1130**



Colori/Colours/Couleurs:
Bianco/White/Blanc
Grigio orione/Orion grey/Gris orion
Faggio/Beech wood/Bois d'hêtre

1152

Portacoltelli legno.
Adatto ad art. **1140, 1130, 1120**
Wooden knife holder.
Suitable for item: **1140, 1130, 1120**
Range-couteaux bois.
Indiqué pour les réf. **1140, 1130, 1120**



1157

Porta pellicole in acciaio inox.
Adatto ad art. **1140, 1130, 1120**
Stainless steel film dispenser.
Suitable for item: **1140, 1130, 1120**
Porte-rouleaux de films en acier inox.
Indiqué pour les réf. **1140, 1130, 1120**



1158

Porta spezie in acciaio inox. Barattoli in vetro
Adatto ad art. **1140, 1130, 1120**
Stainless steel spice tray. Glass jars
Suitable for item: **1140, 1130, 1120**
Porte-épices en acier inox. Pots en verre
Indiqué pour les réf. **1140, 1130, 1120**



Nava - Casiraghi Design



Vassoio scolapiatti rimovibile integrato all'elemento portapiatti

Removable dish draining tray fitted to the plate-holder

Plateau-égouttoir amovible intégré à l'élément range-assiettes



Elementi divisori posizionabili liberamente, ideali per personalizzare gli spazi

Freely placeable dividing elements suitable for personalizing spaces

Éléments de séparation positionnables librement, idéaux pour personnaliser les espaces



Vassoio scolapiatti facilmente trasportabile all'esterno del cestone

Dish draining tray easily extractable from big drawers

Plateau-égouttoir facilement transportable à l'extérieur du grand tiroir



Vassoio raccogli gocce dotato di griglia in acciaio inox satinato

Drip catching tray equipped with satin stainless steel grid

Plateau récolte-gouttes doté de grille en acier inox satiné



Contenitore portaposate rimovibile, integrato al vassoio scolapiatti

Removable cutlery holder fitted to the dish draining tray

Réceptacle range-couverts amovible, intégré au plateau-égouttoir

Colori/Colours/Couleurs:
Bianco/White/Blanc
Grigio orione/Orion grey/Gris orion

base 1200 mm

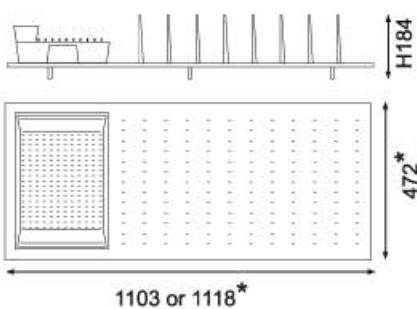

1250

1260

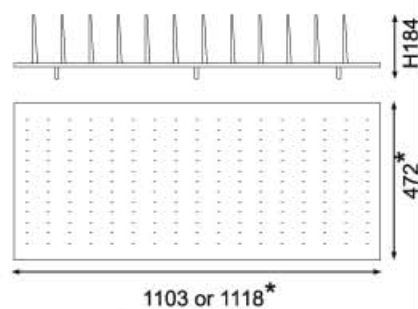

base 900 mm

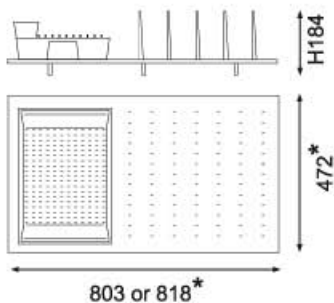

1230

1240

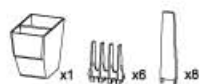
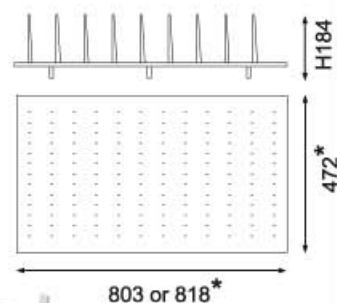

base 600 mm

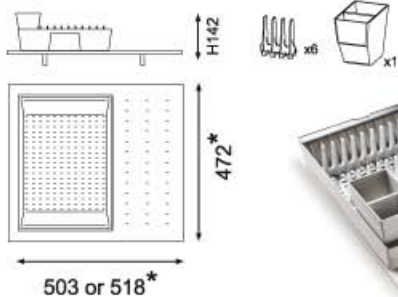

1210

1220

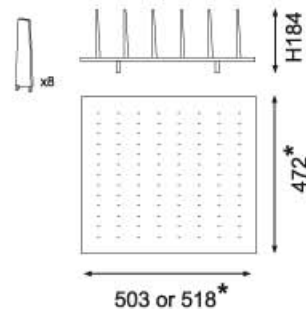

* Disponibili per cassetti Blum®, Grass®, Hettich®, FGV®
Available for drawers: Blum®, Grass®, Hettich®, FGV®
Disponibles pour tiroirs: Blum®, Grass®, Hettich®, FGV®



Elementi divisori e fasce elastiche liberamente posizionabili per consentire la massima personalizzazione degli spazi

Dividers and elastic straps can be positioned at will so that you can arrange the spaces exactly as desired

Les séparateurs et les bandes élastiques peuvent être mis en place sans aucune contrainte, pour permettre une personnalisation optimale des espaces



Scatole multi-uso removibili e trasportabili all'esterno del cestone per un pratico uso anche sul top
Multipurpose removable boxes for handy use also on worktops

Boîtes multi-usages amovibles et transportables à l'extérieur du tiroir pour une utilisation pratique sur le top également



Scatole dotate di supporti per l'aggancio al piano forato per garantire la massima stabilità in apertura e chiusura del cassetto.
Le scatole più piccole sono studiate per l'inserimento nella scatola più grande

Boxes with supports for hooking into the perforated base to ensure maximum stability when opening and closing the drawer.
The smaller boxes are designed to fit inside the largest box.

Boîtes équipées de supports pour la fixation au plan perforé afin de garantir une stabilité maximale au moment de l'ouverture et de la fermeture du tiroir.
Les boîtes les plus petites ont été conçues pour être introduites dans la boîte plus grande.

Colori/Colours/Couleurs:
 Bianco/White/Blanc
 Grigio orione/Orion grey/Gris orion

base 1200 mm

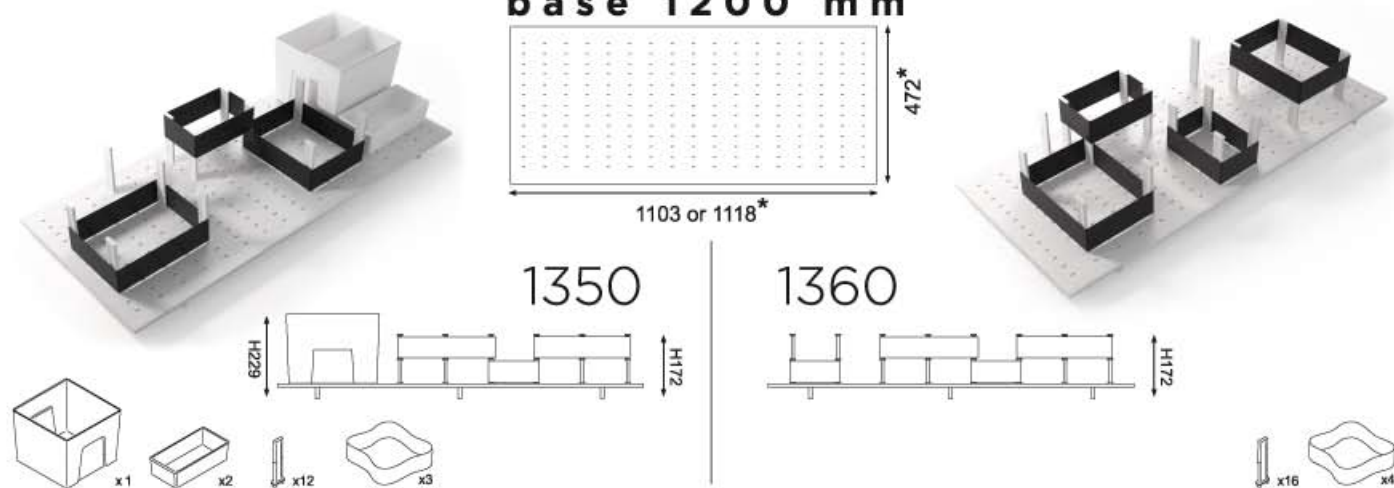

base 900 mm

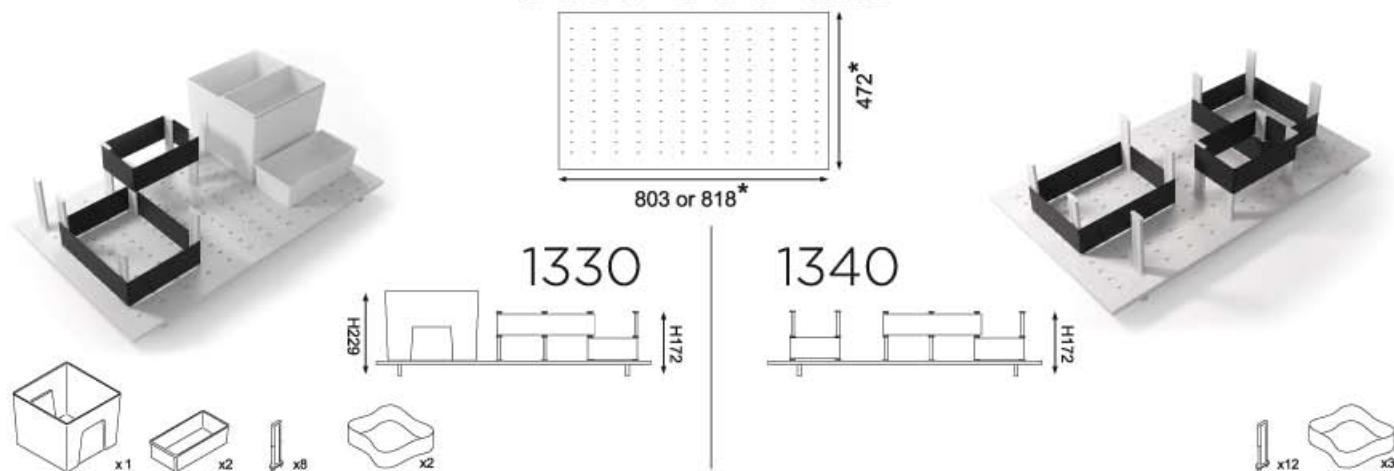

base 600 mm

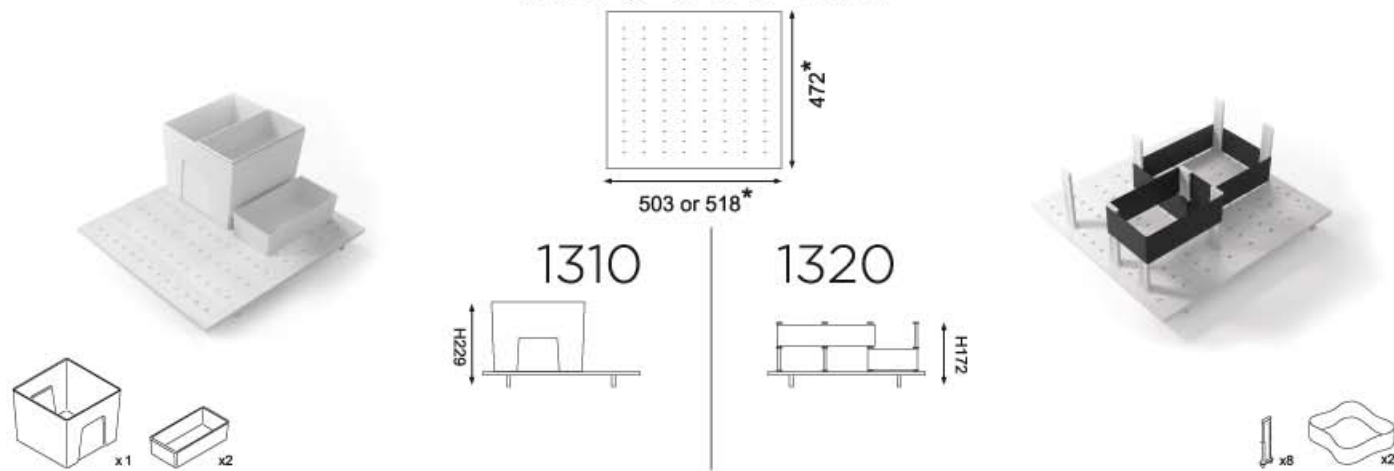

* Disponibili per cassetti Blum®, Grass®, Hettich®, FGV®
 Available for drawers: Blum®, Grass®, Hettich®, FGV®
 Disponibles pour tiroirs: Blum®, Grass®, Hettich®, FGV®



- Disponibile per basi 300, 400, 450, 500, 600 mm
- Available for bases 300, 400, 450, 500, 600 mm
- Disponible pour bases 300, 400, 450, 500, 600 mm

- Telaio in metallo.
- Metal frame.
- Cadre en métal.

- Coperchio in metallo, ideale appoggio per guanti e spugne
- Metal lid ideal for placing sponges and gloves
- Couvercle en métal idéal pour ranger les éponges et les gants

- Capacità totale fino a 80 L
- Total capacity up to 80 L
- Capacité totale jusqu'à 80 L

- Tre altezze disponibili: H529, H485 e H320mm
- Three heights available: H529, H485 and H320mm
- Trois hauteurs disponibles: H529, H485 et H320mm

- Adatto a mobili con pareti laterali da 16 a 19mm di spessore
- Suitable for cabinets with sides thickness from 16 to 19mm
- Adapte pour meubles avec épaisseur laterale de 16 à 19mm



MYZYME™ ATOMIZING SYSTEM

- Il prodotto può essere accessorizzato con lo speciale coperchio con sistema di nebulizzazione per liquido anti odori MYZYME™.
- The product can be equipped with the special atomizing system lid for MYZYME™ anti-odor liquid.
- Le produit peut être équipé avec le spécial couvercle avec système de vaporisation pour le liquide anti-odeur MYZYME™.



Patented

- Coperchio brevettato per la diffusione del liquido enzimatico MYZYME™.
- Patented lid with incorporated atomizing system for enzymatic liquid MYZYME™.
- Couvercle breveté avec système intégré de nébulisation pour liquide enzymatique MYZYME™.

MYZYME™ 100% ECO ANTI-ODOUR ENZYMES

- Il liquido enzimatico MYZYME™ è inodore e totalmente naturale. Nebulizzando il liquido MYZYME™ quotidianamente sui rifiuti organici è possibile eliminare gli odori sgradevoli derivanti dalla raccolta differenziata.
- The MYZYME™ enzyme liquid is odorless and totally natural. Atomizing the MYZYME™ liquid daily on the organic waste permanently eliminates unpleasant odors caused by separate waste collection.
- Le liquide enzymatique MYZYME™ est inodore et totalement naturel. La vaporisation du liquide MYZYME™ quotidiennement sur les déchets organiques peut éliminer définitivement les odeurs désagréables causées par la collecte sélective des déchets.

MYZYME™ BOTTLE

- Il liquido enzimatico MYZYME™ è fornito in bottiglie da 1 litro ciascuna.
- The enzymatic liquid MYZYME™ is supplied in bottles of 1 litre capacity each.
- Le liquide enzymatique MYZYME™ est disponible en flacons avec capacité 1 litre chacun.



base 600 mm

580EVO60C

580EVO60A



D. 458
H. 529



TOT 80 L



10 min



600 mm

SOFT
I I I I I I



D. 458
H. 485*



TOT 74 L



10 min



600 mm

SOFT
I I I I I I



base 500 mm

580EVO50C

580EVO45A



D. 458
H. 529



TOT 80 L



10 min



500 mm

SOFT
I I I I I I



D. 458
H. 485*



TOT 58 L



10 min



450 mm

SOFT
I I I I I I



base 400 mm

580EVO40A

580EVO30C



D. 458
H. 485*



TOT 58 L



10 min



400 mm

SOFT
I I I I I I



D. 458
H. 529*



TOT 40 L



10 min



300 mm

SOFT
I I I I I I



BASE mm	H. 529 mm	H. 485 mm	H. 320 mm
	300	Art.580EVO30C TOT 40 L	
400		Art.580EVO40A ** TOT 58 L	Art.580EVO40B ** TOT 34 L
450		Art.580EVO45A ** TOT 58 L	Art.580EVO45B ** TOT 34 L
500	Art.580EVO50C TOT 80 L		
600	Art.580EVO60C TOT 80 L	Art.580EVO60A ** TOT 74 L	Art.580EVO60B ** TOT 50 L
<p>Versione profondità 450 disponibile su richiesta 450 depth version available on request Version avec profondeur 450 disponible sur demande</p>			

Art. COSPRY580



** Optional / En option:

MYZYME™ ATOMIZING SYSTEM

- Disponibile per secchi da 17 e da 29 L.
- Available for 17 and 29 L bins.
- Disponible pour bacs de 17 et 29 L.

Linea 580 Plus

l'evoluzione della grande capacità
big capacity evolution
l'evolution de la grande capacité



- Disponibile per basi 300, 400, 450, 500, 600 mm
- Available for bases 300, 400, 450, 500, 600 mm
- Disponible pour bases 300, 400, 450, 500, 600 mm
- Telaio in metallo con sponde in plastica. Supporti centrali in metallo
- Metal frame with plastic sides. Metal middle brackets
- Cadre en métal avec bords en plastique. Support central en métal
- Capacità totale fino a 80 L
- Total capacity up to 80 L
- Capacité totale jusqu'à 80 L
- Secchi dotati di coperchio manuale standard; disponibile come optional coperchio MYZYME™
- Bins equipped with standard lids; MYZYME™ optional lid available
- Bacs munis de couvercle standard; disponible, en option, couvercle MYZYME™
- Tre altezze disponibili: H506, H463 e H304mm
- Three heights available: H506, H463 and H304mm
- Trois hauteurs disponibles: H506, H463 et H304mm
- Adatto a mobili con pareti laterali da 16 a 19mm di spessore
- Suitable for cabinets with sides thickness from 16 to 19mm
- Adapte pour meubles avec épaisseur laterale de 16 à 19mm

Linea 580 Plus Optionals

- Coperchio/ripiano ad incasso in metallo satinato o in plastica. Colore grigio orione.
- Built-in satin metal or plastic lid/shelf. Orion grey colour.
- Couvercle/étagère encastrable en métal brossé ou plastique. Couleur gris orion.



coperchio in metallo
metal lid
couvercle en métal



coperchio in plastica
plastic lid
couvercle en plastique

MYZYME™ ATOMIZING SYSTEM

- Il prodotto può essere accessorizzato con lo speciale coperchio con sistema di nebulizzazione per liquido anti odori MYZYME™.
- The product can be equipped with the special atomizing system lid for MYZYME™ anti-odor liquid.
- Le produit peut être équipé avec le spécial couvercle avec système de vaporisation pour le liquide anti-odeur MYZYME™.



Patented

- Coperchio brevettato per la diffusione del liquido enzimatico MYZYME™.
- Patented lid with incorporated atomizing system for enzymatic liquid MYZYME™.
- Couvercle breveté avec système intégré de nébulisation pour liquide enzymatique MYZYME™.

MYZYME™ 100% ECO® ANTI-ODOUR ENZYMES

- Il liquido enzimatico MYZYME™ è inodore e totalmente naturale. Nebulizzando il liquido MYZYME™ quotidianamente sui rifiuti organici è possibile eliminare permanentemente gli odori sgradevoli derivanti dalla raccolta differenziata.
- The MYZYME™ enzyme liquid is odorless and totally natural. Atomizing the MYZYME™ liquid daily on the organic waste permanently eliminates unpleasant odors caused by separate waste collection.
- Le liquide enzymatique MYZYME™ est inodore et totalement naturel. La vaporisation du liquide MYZYME™ quotidiennement sur les déchets organiques peut éliminer définitivement les odeurs désagréables causées par la collecte sélective des déchets.

MYZYME™ BOTTLE

- Il liquido enzimatico MYZYME™ è fornito in bottiglie da 1 litro ciascuna.
- The enzymatic liquid MYZYME™ is supplied in bottles of 1 litre capacity each.
- Le liquide enzymatique MYZYME™ est disponible en flacons avec capacité 1 litre chacun.



Linea 580 Plus

Colori/Colours/Couleurs:
Grigio orione/Orion grey/Gris orion

base 600 mm



580PL60C

D. 458
H. 506



TOT 80 L



10 min



600 mm

SOFT
↓



580PL60A

D. 458
H. 463*



TOT 74 L



10 min



600 mm

SOFT
↓



base 500 mm



580PL50C

D. 458
H. 506



TOT 80 L



10 min



500 mm

SOFT
↓



base 450 mm



580PL45A

D. 458
H. 463*



TOT 58 L



10 min



450 mm

SOFT
↓



base 400 mm



580PL40A

D. 458
H. 463*



TOT 58 L



10 min



400 mm

SOFT
↓



base 300 mm



580PL30C

D. 458
H. 506*



TOT 40 L



10 min











300 mm

SOFT
↓

*Disponibili anche soluzioni H 304 mm / H 304 mm solutions also available/ Disponibles aussi solutions H 304 mm

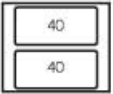
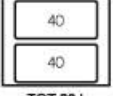
Linea 580 Plus

BASE mm	H. mm		
	H. 506 mm	H. 463 mm	H. 304 mm
300	Art.580PL30C  TOT 40 L		Art.580PL30B  TOT 16 L
		Art.580PL40A **  TOT 58 L	Art.580PL40B **  TOT 34 L
400		Art.580PL45A **  TOT 58 L	Art.580PL45B **  TOT 34 L
	500		
500	Art.580PL50C  TOT 80 L		
	600	Art.580PL60C  TOT 80 L	Art.580PL60A **  TOT 74 L

Versione profondità 450 disponibile su richiesta
450 depth version available on request
Version avec profondeur 450 disponible sur demande

** Optional / En option:

MYZYME™ ATOMIZING SYSTEM

- Disponibile per secchi da 17 e da 29 L.
- Available for 17 and 29 L bins.
- Disponible pour bacs de 17 et 29 L.

Art. COSPRY580

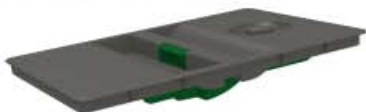

Optional / En option:

- coperchio ad incasso, in plastica o in metallo
- built-in plastic or metal lid
- couvercle encastrable, en plastique ou en métal

coperchio in metallo
metal lid
couvercle en métal

Art. COP560

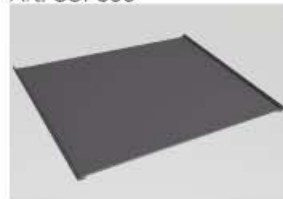

coperchio in plastica
plastic lid
couvercle en plastique

Art. COPTRAD





large capacity waste bins

Linea 560 restyling



large capacity waste bins

Linea 560 restyling

Nuovo design
New design / Nouveau design

Nuovo colore disponibile: grigio orione
New colour available: orion grey / Nouvelle couleur disponible: gris orion



Art.560G46050C



Art.560G44550A
+ MYZYME™
ATOMIZING SYSTEM



Optional / En option:

MYZYME™ ATOMIZING SYSTEM

- Coperchio brevettato per la diffusione del liquido enzimatico MYZYME™. Disponibile per secchi da 17 e da 29 L.
- Patented lid with incorporated atomizing system for enzymatic liquid MYZYME™. Available for 17 and 29 L bin.
- Couvercle breveté avec système intégré de nébulisation pour liquide enzymatique MYZYME™. Disponibles pour bacs de 17 et 29 L.



Optional / En option:

- coperchio ad incasso, in plastica o in metallo
- built-in plastic or metal lid
- couvercle encastrable, en plastique ou en métal



coperchio in metallo
metal lid
couvercle en métal



coperchio in plastica
plastic lid
couvercle en plastique

Linea 560 restyling

Colori/Colours/Couleurs:
Grigio orione/Orion grey/Gris orion
Grigio/Grey/Gris



- Compatibile con sponde da cassetto:
- Available for drawer slides:
- Disponibles pour côtés des tiroirs:



- Disponibile per base 300, 400, 450, 500, 600, 800, 900 mm e per profondità 500 e 450 mm
- Available for bases 300, 400, 450, 500, 600, 800, 900 mm and for 500 and 450 mm depth
- Disponibles pour bases 300, 400, 450, 500, 600, 800, 900 mm et pour profondeur 500 et 450 mm

- Capacità totale fino a 84 L
- Total capacity up to 84 L
- Capacité totale jusqu'à 84 L

- Secchi dotati di coperchio manuale standard
- Bins equipped with standard lids
- Bacs munis de couvercle standard

- Altezze disponibili: H506, H463 e H298mm
- Heights available: H506, H463 and H298mm
- Hauteurs disponibles: H506, H463 et H298mm

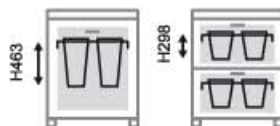

- Adatto a mobili con pareti laterali da 16 a 19mm di spessore
- Suitable for cabinets with sides thickness from 16 to 19mm
- Adapte pour meubles avec épaisseur laterale de 16 à 19mm

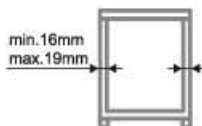

- Telaio in metallo con sponde in plastica. Supporti centrali in metallo
- Metal frame with plastic sides. Metal middle brackets
- Cadre en métal avec bords en plastique. Support central en métal



Linea 560 restyling



BASE mm	Per Profondità For Drawer Depth Pour Profondeur 500 mm			Per Profondità For Drawer Depth Pour Profondeur 450 mm	
	H. 506 mm	H. 463 mm	H. 298 mm	H. 463 mm	H. 298 mm
300			Art.5603050B TOT 16 L		
400		Art.5604050A TOT 37 L	Art.5604050B TOT 25 L	Art.5604045A TOT 29 L	Art.5604045B TOT 17 L
450		Art.5604550A TOT 58 L	Art.5604550B TOT 34 L	Art.5604545A TOT 40 L	Art.5604545B TOT 28 L
500		Art.5605050A TOT 58 L	Art.5605050B TOT 34 L	Art.5605045A TOT 40 L	Art.5605045B TOT 28 L
600	Art.5606050C TOT 80 L	Art.5606050A TOT 74 L	Art.5606050B TOT 50 L	Art.5606045A TOT 58 L	Art.5606045B TOT 34 L
800			Art.5608050B TOT 68 L		Art.5608045B TOT 56 L
900			Art.5609050B TOT 84 L		Art.5609045B TOT 62 L

Optional / En option:

- Coperchio ad incasso, in plastica o in metallo
- Built-in plastic or metal lid
- Couvercle encastrable, en plastique ou en métal
- Guide e sponde da cassetto
- Drawer slides and drawer sides
- Glissières et côtés pour tiroir
- Coperchio brevettato per la diffusione del liquido enzimatico MYZYME™. Disponibile per secchi da 17 e da 29 L.
- Patented lid with incorporated atomizing system for enzymatic liquid MYZYME™. Available for 17 and 29 L bin.
- Couvercle breveté avec système intégré de nébulisation pour liquide enzymatique MYZYME™. Disponibles pour bacs de 17 et 29 L.



large capacity waste bins

Linea 570 Nava/Casiraghi design
Linea 571 Metal

Per sistemi cassetto Blum Legrabox®

For Blum Legrabox® drawer systems

Pour systèmes tiroir Blum Legrabox®



Nava Casiraghi Design

Linea 570 Nava/Casiraghi design Linea 571 Metal

Linea 570 Nava/Casiraghi design

• L'elegante sistema in legno ed alluminio, disegnato da Paolo Nava e Fabio Casiraghi, consente di sfruttare al meglio lo spazio all'interno del cassetto creando un solido appoggio per i capienti raccoglitori e ricavando due pratici vani laterali portaoggetti (ideali per contenere spugne, rotoli di sacchetti, guanti, prodotti per la pulizia, ecc.).

• The elegant wooden and aluminum system, designed by Paolo Nava and Fabio Casiraghi, allows to make the most of the space inside the drawer by creating a solid support for the big hanging bins and obtaining two practical side storage compartments (ideal for storing sponges, rolls of bags, gloves, cleaning products, etc.).

• L'élégant système en bois et aluminium, conçu par Paolo Nava et Fabio Casiraghi, permet de tirer le meilleur parti de l'espace intérieur du tiroir en créant un support solide pour les bacs grande capacité et permettant d'obtenir deux pratiques compartiments de rangement latéraux (idéals pour stocker des éponges, rouleaux de sacs, gants, produits de nettoyage, etc.).



- La cornice di supporto in alluminio è facilmente estraibile per agevolare la pulizia del prodotto.
- The aluminum support frame can be removed to facilitate product cleaning.
- Le châssis de support en aluminium peut être enlevé pour un nettoyage facile du produit.

Linea 571 Metal



• Telaio in metallo verniciato color grigio orione. Studiato per sistemi cassetto Blum Legrabox® altezza C (177mm), profondità 500mm.

• Orion grey painted metal frame. Designed for Blum Legrabox® drawer systems C height (177mm), 500mm depth.

• Cadre en metal peint en gris orion. Conçu pour systèmes de tiroirs Blum Legrabox® hauteur C (177mm), 500mm de profondeur.



- Montaggio facile e veloce.
- Quick and easy installation.
- Installation rapide et facile.

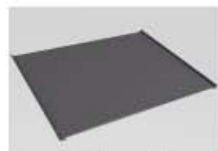

coperchio in metallo
metal lid
couvercle en métal



coperchio in plastica
plastic lid
couvercle en plastique

• Forniti di coperchio/ripiano ad incasso in metallo satinato o in plastica. Colore grigio orione.

• Supplied with built-in satin metal or plastic lid/shelf. Orion grey colour.

• Equipés avec couvercle/étagère encastrable en métal brossé ou plastique. Couleur gris orion.

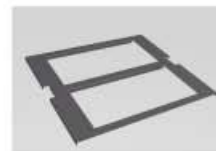

• Cover in alluminio satinato, colore grigio orione.

• Satin aluminium cover, orion grey colour.

• Couverture en aluminium brossé, couleur gris orion.

Linea 570 Nava/Casiraghi design

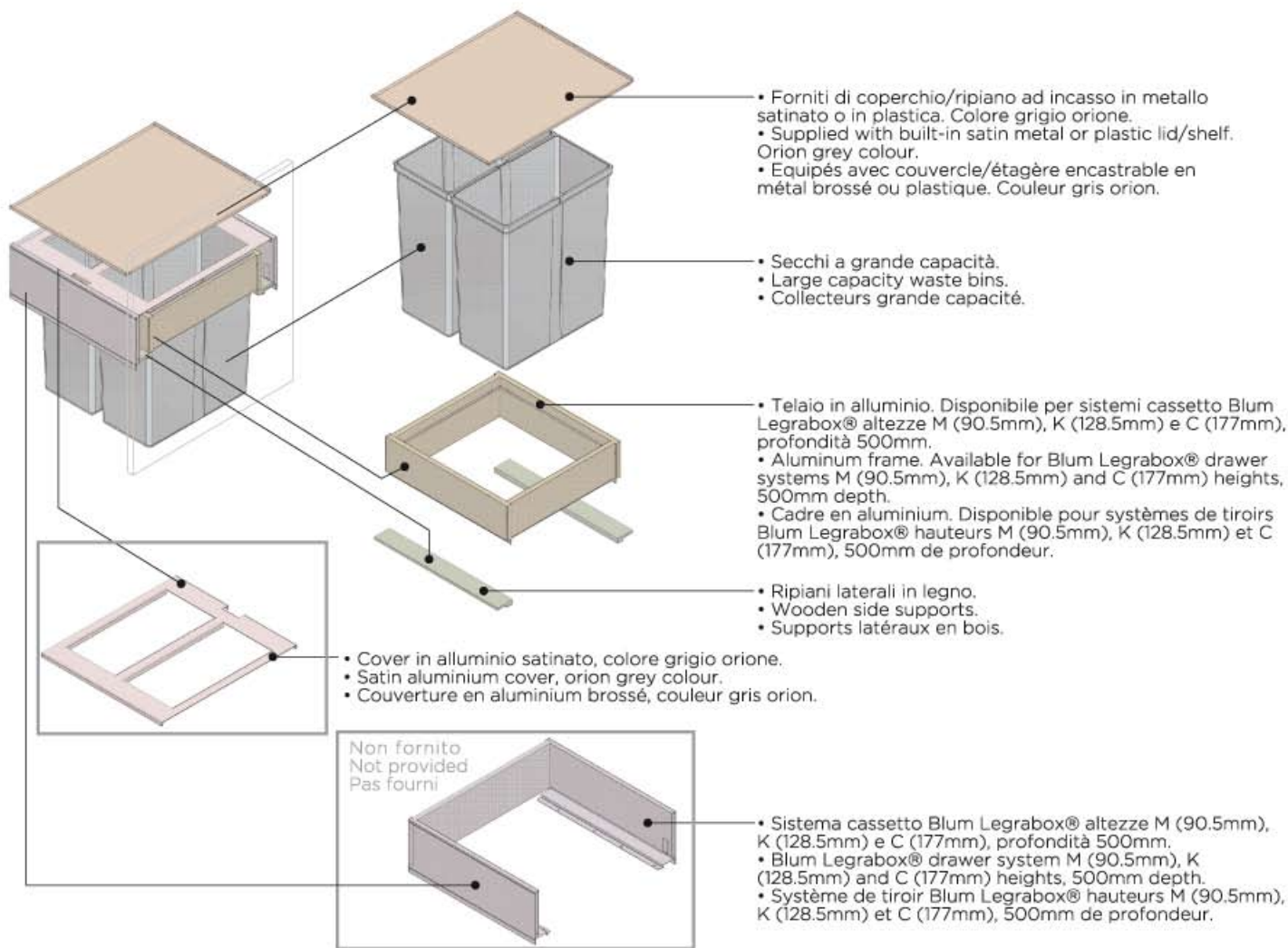

⚠

- I codici indicati in tabella si riferiscono agli articoli adatti al sistema cassetto Blum Legrabox® altezza M.
- The codes shown in the table refer to the items suitable for Blum Legrabox® drawer system M height.
- Les codes indiqués dans le tableau se réfèrent aux références propres au système de tiroirs Blum Legrabox® hauteur M.



Coperchi manuali non inclusi
Manual lids not included
Couvercles manuels pas inclus

BASE mm	H. 505 mm	H. 463 mm
400		 Art. 570G44050A TOT 37 L
450		 Art. 570G44550A TOT 37 L
500		 Art. 570G45050A TOT 58 L
600	 Art. 570G46050C TOT 80 L	

large capacity waste bins

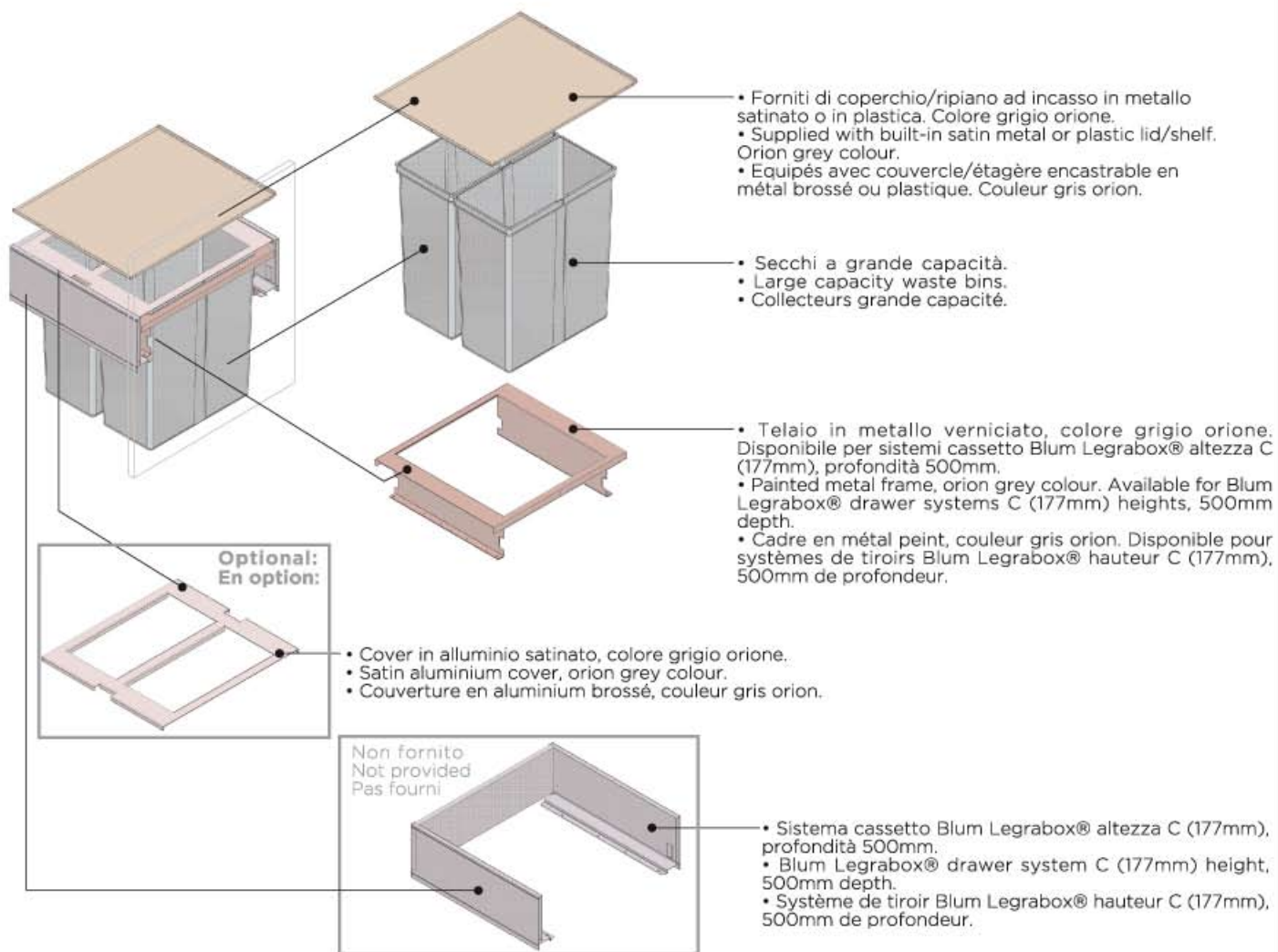
Linea 571 Metal



BASE mm	H. 505 mm	H. 463 mm
450		 <p>Art. 571G44550A TOT 37 L</p>
600	 <p>Art. 571G46050C TOT 80 L</p>	

Coperchi manuali non inclusi
Manual lids not included
Couvercles manuels pas inclus



Enrico Tommasini Design

- Adatto per base min. 450 mm.
- Fissaggio al fondo del mobile
- Guide ad estrazione totale
- Kit per fissaggio all'anta_ optional art. 555

- Fits minimum 450 mm cabinet
- Fixing to the bottom of the cabinet
- Full extension slides
- Door mounting fixing kit_ optional art. 555

- Adapté pour base min. 450 mm
- Fixation sur fond du meuble
- Glissières à sortie totale
- Kit pour fixation sur porte_ en option art. 555



550

Colori/Colours/Couleurs:
Grigio
Grey
Gris



551

70
LITRI



TOT 70 L



5 min



min.450 mm



TOT 60 L



5 min



min.450 mm



60
LITRI

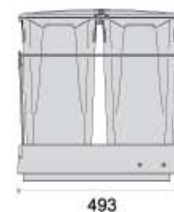
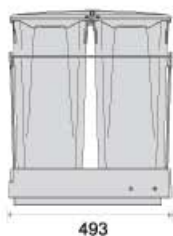

Optional Linea 550

555

- Kit per fissaggio all'anta / optional per art. 550 e art. 551
- In dotazione: 4 elementi in metallo verniciato, viteria necessaria per montaggio, istruzioni.
- Door mounting fixing kit / optional item for art. 550 and art. 551
- It includes: 4 painted metal elements, bolts and screws necessary for assembling and fitting, instructions sheet
- Kit pour fixation sur porte / en option pour art. 550 et art. 551
- Cela comprend: 4 éléments en métal peint, vis et boulons nécessaires pour le montage et le réglage, notice de montage

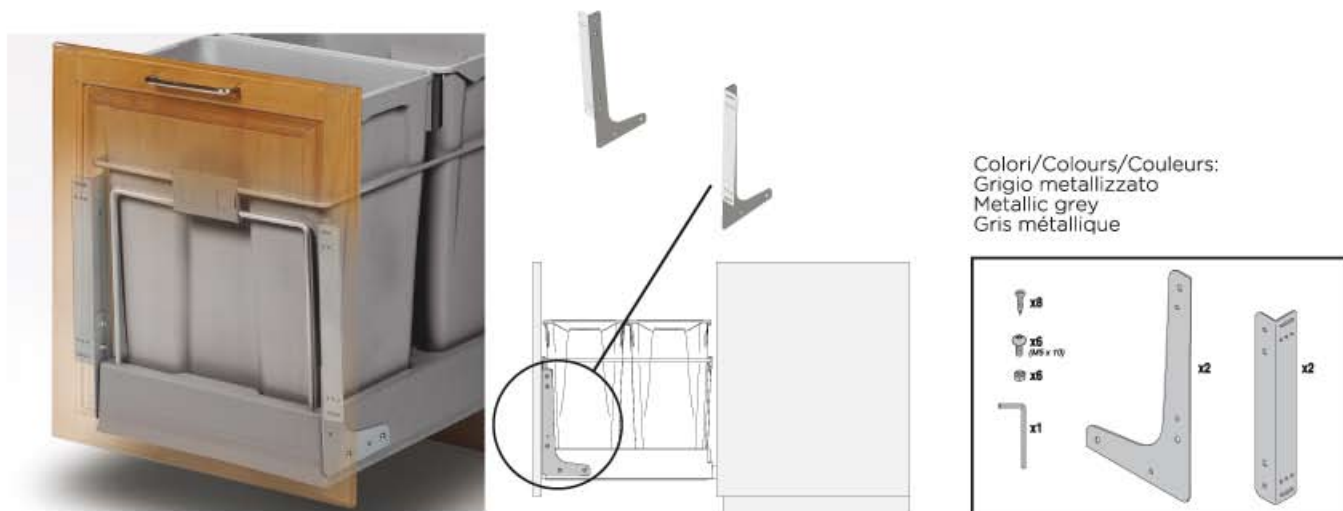

Optional Linea 550

557



Colori/Colours/Couleurs:

Grigio, coperchio verde
Grigio quarzo, coperchio grigio fumé

Grey, green lid
Quartz grey, smoke grey lid

Gris, couvercle vert
Gris quartz, couvercle gris fumé

- Posizionabile all'interno dei raccoglitori linea 550
- Can be placed inside 550 Line waste bins
- Positionnable dans les collecteurs ligne 550





- Sistema brevettato di fuoriuscita automatica
- Chiusura ammortizzata
- Coperchio studiato per l'appoggio di guanti e spugne, facilmente smontabile per agevolare la pulizia
- Adatto a base min. 450 mm con fissaggio per estrazione automatica
- Posizionabile su base min. **400** mm in caso di fissaggio per estrazione manuale
- Patented automatic pull-out system
- Damped closing
- Lid designed to rest sponges and gloves on, easy to remove to facilitate cleaning
- Fits minimum 450 mm cabinet (automatic pull-out system)
- Can be fixed into a min. **400** mm cabinet in case of manual pull-out extraction
- Système breveté de sortie automatique
- Fermeture amortie
- Couvercle conçu pour ranger éponges et gants, décrochement rapide pour simplifier le nettoyage
- Adapté pour base min. 450 avec fixation du système de sortie automatique
- Peut être logé dans base min. **400** mm en cas de fixation pour extraction manuelle

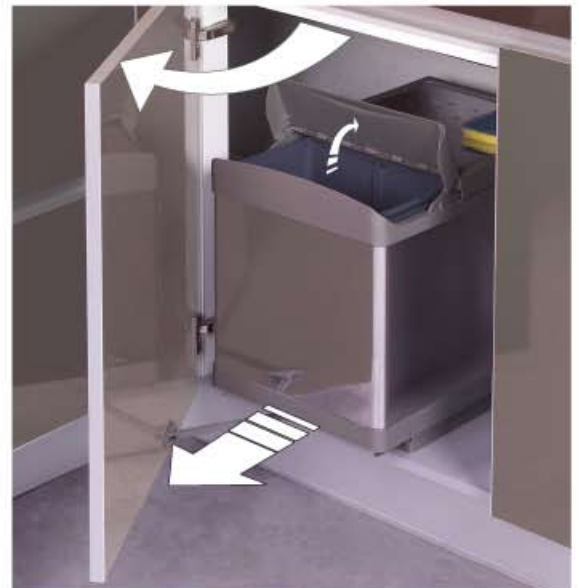

pull-out waste bins
Linea 500



Colori/Colours/Couleurs:
Grigio / Grey / Gris

538
511*



W. 343
D. 475
H. 433



10 min



min 450 mm



automatic



516
503*



W. 343
D. 475
H. 372

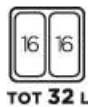

10 min



min 450 mm



automatic



517
504*



W. 343
D. 475
H. 372



10 min



min 450 mm



automatic



*

Versioni con coperchio e involucro in acciaio inox
Lid and outer body stainless steel versions
Versions avec couvercle et corps en acier inox

Colori/Colours/Couleurs:
Grigio quarzo

Quartz grey

Gris quartz





- Sistema brevettato di fuoriuscita automatica
- Adatto a base min. 400 mm con fissaggio per estrazione automatica
- Posizionabile su base min. **350** mm in caso di fissaggio per estrazione manuale
- Patented automatic pull-out system
- Fits minimum 400 mm cabinet (automatic pull-out system)
- Can be fixed into a min. **350** mm cabinet in case of manual pull-out extraction
- Système breveté de sortie automatique
- Adapté pour base min. 400 avec fixation du système de sortie automatique
- Peut être logé dans base min. **350** mm en cas de fixation pour extraction manuelle

Colori/Colours/Couleurs:

Grigio chiaro
Light grey
Gris clair



Linea Lucci-Orlandini

240
250*



W. 267
D. 440
H. 420



242
252*



W. 267
D. 440
H. 352



*
Versioni con involucro in acciaio inox
Outer body stainless steel versions
Versions avec corp en acier inox





Contenitori per la raccolta differenziata, ideali per spazi ridotti (base min. 300 mm). Dimensioni compatte, grande capacità (fino a 42 L) ed installazione rapida sotto qualsiasi tipo di livello.

Containers for separate waste collection, the ideal solution for small spaces (minimum base 300 mm). Compact dimensions, great capacity (up to 42 L) and quick installation under every kind of sink.

Collecteurs pour le tri sélectif, la solution idéale pour les espaces réduits (base min. 300 mm). Dimensions compactes, grande capacité (jusqu'à 42 L) et installation rapide sous tout type d'évier.



Dotato di speciali guide ad estrazione totale.

Equipped with special full extension slides.

Équipé avec spéciales glissières à extraction totale.



Coperchio studiato per facilitare l'apertura e la chiusura in presenza di rifiuti sporgenti.

Lid studied to facilitate the opening and closing in the presence of jutting out waste.

Couvercle étudié pour faciliter l'ouverture et la fermeture en présence de déchets en saillie.



Il coperchio consente l'appoggio di guanti, spugne e piccoli oggetti.

The lid allows the rest of gloves, sponges and small objects.

Le couvercle permet l'appui de gants, éponges et petits objets.



Coperchio facilmente rimovibile per semplificarne la pulizia.

The lid can be easily removed for a better cleaning.

Le couvercle est aisément amovible pour en simplifier le nettoyage.



Linea 222

Colori/Colours/Couleurs:
Grigio / Grey / Gris

294



40
LITRI

W. 255
D. 450
H. 537



TOT 40 L



2 min



min 300 mm

224



30
LITRI

W. 255
D. 450
H. 400



TOT 30 L



2 min



min 300 mm

223



30
LITRI

W. 255
D. 450
H. 400



TOT 30 L



2 min



min 300 mm



222



28
LITRI

W. 255
D. 450
H. 400



TOT 28 L



2 min



min 300 mm





Colori/Colours/Couleurs:
Grigio / Grey / Gris

290



42
LITRI

W. 343
D. 473
H. 400



TOT 42 L



2 min



min 400 mm



291



32
LITRI

W. 343
D. 473
H. 339



TOT 32 L



2 min



min 400 mm



292



31
LITRI

W. 343
D. 473
H. 339



TOT 31 L



2 min



min 400 mm



NEW COLOUR



Contenitori per la raccolta differenziata, ideali per spazi ridotti (base min. 300 mm). Installazione rapida sotto qualsiasi tipo di lavello.

Containers for separate waste collection, the ideal solution for small spaces (minimum base 300 mm). Quick installation under every kind of sink.

Collecteurs pour le tri sélectif, la solution idéale pour les espaces réduits (base min. 300 mm). Installation rapide sous tout type d'évier.



Il coperchio consente l'appoggio di guanti, spugne e piccoli oggetti.

The lid allows the rest of gloves, sponges and small objects.

Le couvercle permet l'appui de gants, éponges et petits objets.

Enrico Tommasini Design

Colori/Colours/Couleurs:
Grigio / Grey / Gris

227

28
LITRI



W. 255
D. 450
H. 398



TOT 28 L



2 min



min 300 mm



226

21
LITRI



- In dotazione 1 vaschetta multiuso
- Equipped with 1 multi-use removable tray
- En dotation 1 bac amovible tous usages

W. 255
D. 450
H. 398



TOT 21 L



2 min



min 300 mm



Sollevamento automatico del coperchio tramite sistema brevettato

Automatic lid opening by means of a patented system

Ouverture automatique du couvercle grâce à un mécanisme breveté

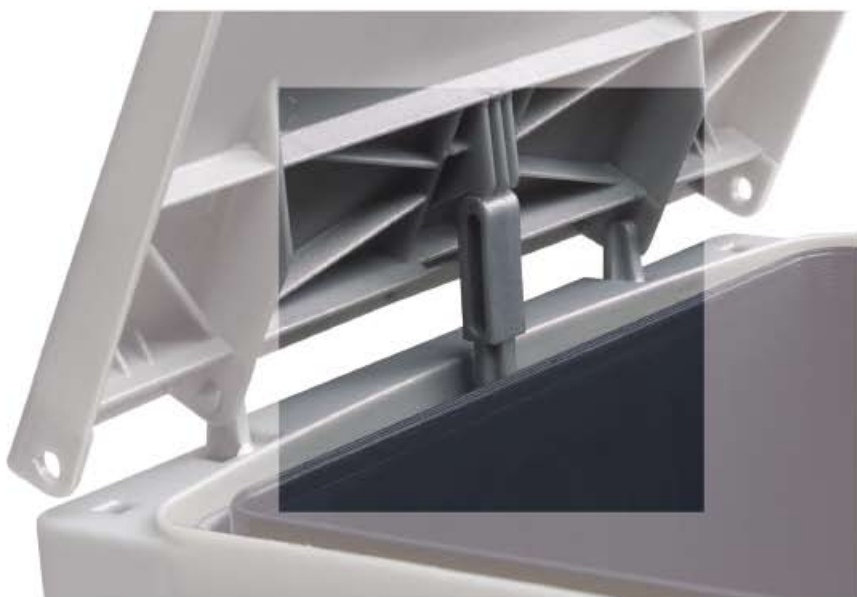

Contenitori per la raccolta differenziata, ideali per spazi ridotti (base min. 300 mm). Installazione rapida sotto qualsiasi tipo di lavello.

Containers for separate waste collection, the ideal solution for small spaces (minimum base 300 mm). Quick installation under every kind of sink.

Collecteurs pour le tri sélectif, la solution idéale pour les espaces réduits (base min. 300 mm). Installation rapide sous tout type d'évier.

286

Colori/Colours/Couleurs:
Grigio metallizzato / Metallic grey / Gris metallique

Involucro esterno in acciaio inox
Stainless steel outer body
Corp extérieur en acier inox



W. 230
D. 380
H. 423



Colori/Colours/Couleurs:
Bianco / White / Blanc
Grigio chiaro / Light grey / Gris clair



W. 230
D. 380
H. 360



283
284*

280
281*



W. 230
D. 380
H. 360



*
Versioni con involucro in acciaio inox
Outer body stainless steel versions
Versions avec corps en acier inox

Colori/Colours/Couleurs:
Grigio metallizzato

Metallic grey

Gris metallique

INOX





waste bins for large drawer

Sistema 9XL

Secchi extra large

Extra large bins

Seaux extra larges



Colori/Colours/Couleurs:
Grigio orione/Orion grey/Gris orion

- Secchi molto capienti per agevolare la raccolta differenziata dei rifiuti più ingombranti (bottiglie di plastica e vetro, lattine, cartone per alimenti...).
- Extra large bins to make separate collection of bulky refuse easier (glass and plastic bottles, cans, food paperboard...).
- Bacs de grande capacité pour faciliter le tri sélectif des déchets les plus encombrants (bouteilles en verre et plastique, canettes, carton à usage alimentaire...).

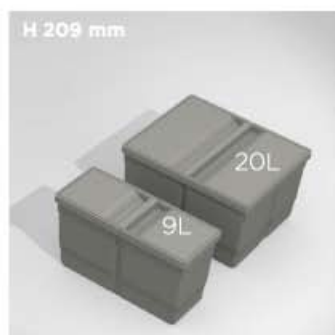
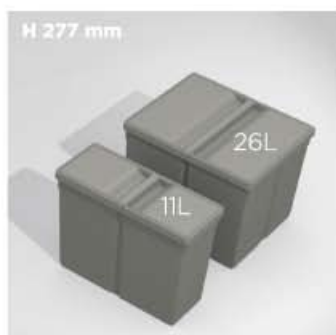

- Secchi disponibili in due altezze e in due larghezze differenti.
- Bins available in two different sizes and heights.
- Bacs disponibles en deux différents largeurs et hauteurs.

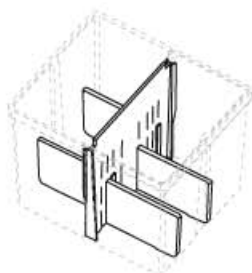

- Optional: portadetersivi con separatori regolabili. Utile per trasportare ed organizzare ordinatamente i principali prodotti per la pulizia della casa. Il separatore centrale può essere utilizzato anche come divisorio consentendo di ottenere due vani per la raccolta differenziata all'interno di un unico secchio.
- Optional: detergent-holder with adjustable dividers. Useful for carrying and organising the main household cleaning products. The central divider can also be used as a partition allowing to obtain two compartments for separate collection within a single bucket.
- En option: porte-détergents avec séparateurs réglables. Pratique pour transporter et organiser les principaux produits de nettoyage ménager. Le séparateur central peut également être utilisé comme une partition permettant d'obtenir deux compartiments pour la collecte séparée dans un seul seau.



- Optional: coperchio automatico dotato di sistema di fissaggio ai fianchi interni del mobile.
- Optional: automatic lid equipped with fixing system to the sides of the cabinet.
- En option: couvercle automatique avec système de fixation sur les côtés du meuble.





- Il prodotto può essere accessorizzato con lo speciale coperchio con sistema di nebulizzazione per liquido anti odori MYZYME™.
- The product can be equipped with the special atomizing system lid for MYZYME™ anti-odor liquid.
- Le produit peut être équipé avec le spécial couvercle avec système de vaporisation pour le liquide anti-odeur MYZYME™.

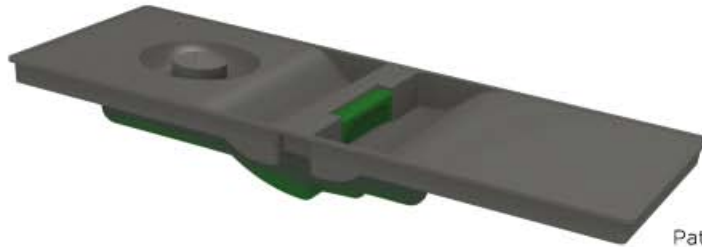

Patented

MYZYME™ ATOMIZING SYSTEM

- Coperchio brevettato per la diffusione del liquido enzimatico MYZYME™. Il coperchio può essere fornito sia separatamente come optional sia incluso nella confezione dei raccoglitori.
- Patented lid with incorporated misting system for enzymatic liquid MYZYME™. The lid may be provided either separately as an option or included in the package with the collectors.
- Couvercle breveté avec système intégré de nébulisation pour liquide enzymatique MYZYME™. Le couvercle peut être fourni séparément en option ou inclus dans le module avec les collecteurs.



MYZYME™
100% ECO
ANTI-ODOUR ENZYMES

- Il liquido enzimatico MYZYME™ è inodore e totalmente naturale. Nebulizzando il liquido MYZYME™ quotidianamente sui rifiuti organici è possibile eliminare permanentemente gli odori sgradevoli derivanti dalla raccolta differenziata.
- The MYZYME™ enzyme liquid is odorless and totally natural. Atomizing the MYZYME™ liquid daily on the organic waste permanently eliminates unpleasant odors caused by separate waste collection.
- Le liquide enzymatique MYZYME™ est inodore et totalement naturel. La vaporisation du liquide MYZYME™ quotidiennement sur les déchets organiques peut éliminer définitivement les odeurs désagréables causées par la collecte sélective des déchets.



Colori/Colours/Couleurs:
Grigio orione/Orion grey/Gris orion

BASE
mm



Vassoio / Tray / Plateau
(min-max) mm

H. 277

H. 209

1200

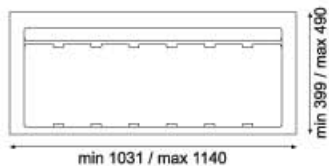

TOT 89 L



TOT 69 L

1000

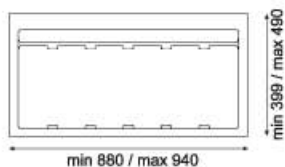

TOT 74 L



TOT 58 L

900

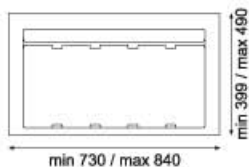

TOT 63 L



TOT 49 L

800 - 700

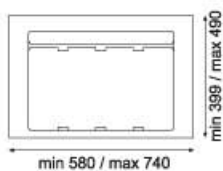

TOT 48 L



TOT 38 L

600

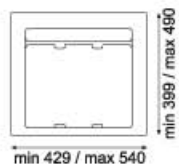

TOT 37 L



TOT 29 L

500 - 450 - 400



TOT 22 L



TOT 18 L

Sistema 9XL Optionals



Art. COPTRA

- Coperchio automatico dotato di sistema di fissaggio ai fianchi interni del mobile.
- Automatic lid equipped with fixing system to the sides of the cabinet.
- Couvercle automatique avec système de fixation sur les côtés du meuble.

Art. COSPRY9XL

MYZYME™ ATOMIZING SYSTEM

- Coperchio brevettato per la diffusione del liquido enzimatico MYZYME™.
- Patented lid with incorporated atomizing system for enzymatic liquid MYZYME™.
- Couvercle breveté avec système intégré de nébulisation pour liquide enzymatique MYZYME™.



Art. 9XLZYME1L

MYZYME™ BOTTLE

- Il liquido enzimatico MYZYME™ è fornito in bottiglie da 1 litro ciascuna.
- The enzymatic liquid MYZYME™ is supplied in bottles of 1 litre capacity each.
- Le liquide enzymatique MYZYME™ est disponible en flacons avec capacité 1 litre chacun.

Prodotti abbinabili con elemento in alluminio per **cestone sottolavello**
Products can be combined with aluminium element for **under-sink drawer**
Produits combinables avec élément en aluminium pour **tiroir sous-évier**



NEW
Art. 955
PAG.56



In dotazione: 5 icone adesive applicabili sui coperchi per semplificare la raccolta differenziata.

Equipped with: 5 adhesive icons applicable on the lids to make separate waste collection easier

Équipé de: 5 icônes adhésives applicables sur les couvercles pour simplifier la collecte sélective.

Colore/Colour/Couleur:
Grigio / Grey / Gris

BASE
mm



Vassoio / Tray / Plateau
(min-max) mm

H. 250

1200

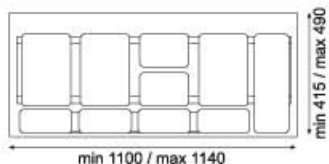

916

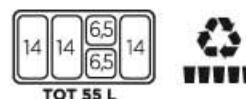

1000

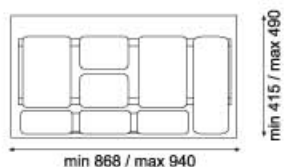

946



900

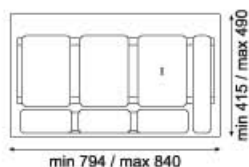

906



800

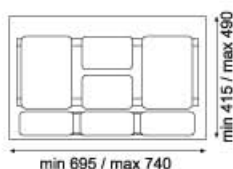

940



600

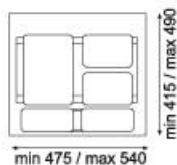

908



waste bins for large drawer

Sistema 900

coperchio automatico / automatic lid / couvercle automatique



Per tutte le basi (1200, 1000, 900, 800, 600 mm) sono disponibili versioni con coperchio automatico (H+20mm)
Versions with automatic lid (H+20mm) are available for all the bases (1200, 1000, 900, 800, 600 mm)
Pour toutes les bases (1200, 1000, 900, 800, 600 mm) des versions avec couvercle automatique sont disponibles (H+20mm)

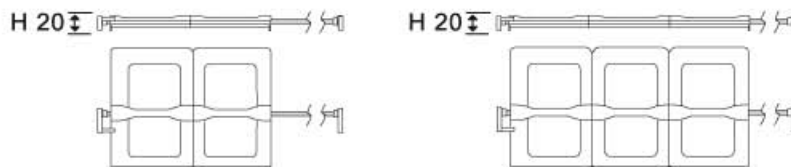

Colori/Colours/Couleurs:
Grigio/Grey/Gris

Kit 900

Kit906

H. 250



TOT:41



Secchi non forniti di vassoio
Tray not included
Plateau pas inclu

Kit908S

H. 250



TOT:28



Secchi non forniti di vassoio
Tray not included
Plateau pas inclu

Kit908

H. 250



TOT:27



Secchi non forniti di vassoio
Tray not included
Plateau pas inclu



Divisorio rimovibile.
Removable divider.
Separateur amovible.

200ix

Colori/Colours/Couleurs:

Grigio metallizzato / Metallic grey /
Gris métallique

Involucro esterno in acciaio inox
Stainless steel outer body
Corp extérieur en acier inox

INOX



Sollevamento automatico del coperchio (sistema brevettato)
Automatic lid opening (patented system)
Ouverture automatique du couvercle (mécanisme breveté)

W. 230
D. 353
H. 386



TOT 21 L



3 min



min 500 mm



Colori/Colours/Couleurs:

Bianco / White / Blanc

Grigio chiaro / Light grey / Gris clair

201 201ix*

202 202ix*



W. 230
D. 353
H. 333



TOT 16 L



3 min



min 500 mm

W. 230
D. 353
H. 333



TOT 15 L



3 min



min 500 mm



*

Versioni con involucro in acciaio inox
Outer body stainless steel versions
Versions avec corps en acier inox

Colori/Colours/Couleurs:
Grigio metallizzato / Metallic grey / Gris métallique

INOX





Sollevamento automatico del coperchio
(sistema brevettato)
Automatic lid opening
(patented system)
Ouverture automatique du couvercle
(mécanisme breveté)



274

Colori/Colours/Couleurs:
Grigio metallizzato / Metallic grey /
Gris métallique
Nero / Black / Noir

Involucro esterno e coperchio in
acciaio inox
Stainless steel outer body and lid
Corps extérieur et couvercle en acier
inox

INOX

W. 277
D. 277
H. 355



TOT 13 L



2 min



min 400 mm

272

Colori/Colours/Couleurs:
Bianco / White / Blanc
Grigio metallizzato / Metallic grey /
Gris métallique
Nero / Black / Noir

Involucro esterno in acciaio inox
Stainless steel outer body
Corps extérieur en acier inox

INOX

W. 277
D. 277
H. 355



TOT 13 L



2 min



min 400 mm



275

Colori/Colours/Couleurs:
Bianco / White / Blanc

Involucro esterno in metallo
laccato bianco
White lacquered metal outer body
Corps extérieur en métal finition
blanc

METAL

W. 277
D. 277
H. 355



TOT 13 L



2 min



min 400 mm

270

Colori/Colours/Couleurs:
Bianco / White / Blanc
Grigio metallizzato / Metallic grey /
Gris métallique

W. 277
D. 277
H. 355



TOT 13 L



2 min



min 400 mm



elemento per cestone sottolavello
 element for under-sink drawer / élément pour tiroir sous-évier



Struttura autoportante in alluminio verniciato.
 Studiata per i sistemi cassetto Blum Legrabox® nelle altezze M (90.5mm) e C (177mm). Adattabile ai vari tipi di larghezze e di profondità.
 Dotato di vaschette removibili. Particolarmente adatto per abbinamenti con raccoglitori della Collezione Première (pag.10) e Sistema 9XL (pag.46).

Self-supporting structure in painted aluminum.
 Designed for Blum Legrabox® drawer systems in heights M (90.5mm) and C (177mm). Adaptable to various types of widths and depths.
 Equipped with removable trays. Designed to match with Première Collection waste bins (pag.10) and 9XL System (pag.46).

Structure autoportante en aluminium peint.
 Conçu pour les systèmes de tiroirs Blum Legrabox® de hauteur M (90.5mm) et C (177mm). Adaptable à différents types de largeurs et de profondeurs. Equipé de bacs amovibles. Combinable avec les collecteurs de la Collection Première (pag.10) et du Système 9XL (pag.46).



ALUMINIUM

955

H. 75



2 min

110top

Raccogliatore in acciaio inox ad incasso a filo top o lavello della cucina

In dotazione:

- A_coperchio in acciaio inox con presa ergonomica
- B_guarnizione in gomma
- C_secchio in acciaio inox
- D_cornice di collegamento in acciaio inox

Stainless steel countertop or sink waste bin.

It includes:

- A_stainless steel lid with ergonomic handle
- B_rubber ring
- C_stainless steel bin
- D_stainless steel ring

Collecteur en acier inox à encastrer à fleur du plan de travail ou de l'évier de la cuisine.

En dotation:

- A_couvercle en acier inox avec prise ergonomique
- B_joint en caoutchouc
- C_seau en acier inox
- D_encadrement en acier inox

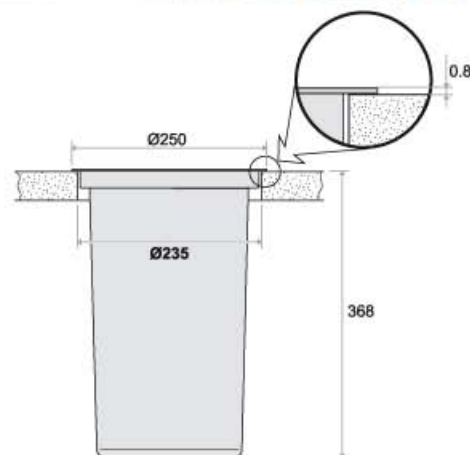

TOT 10 L

INOX

Non vendibile in Francia / Not saleable in France / Non vendable en France

557

Colori/Colours/Couleurs:

Grigio, coperchio verde
Grigio quarzo, coperchio grigio fumé

Grey, green lid
Quartz grey, smoke grey lid

Gris, couvercle vert
Gris quartz, couvercle gris fumé



W. 247
D. 185
H. 182



TOT 5 L



+ ♻️

210

Colori/Colours/Couleurs:

Bianco / White / Blanc

Raccogliatore di forma semicircolare (12 L) con fissaggio all'anta del mobile. Sollevamento del coperchio all'apertura dell'anta tramite cordino.

Semicircular 12-litre waste bin to be fixed to the furniture door. The lid lifts upon opening of the door by means of a twine.

Collecteur de forme semi-circulaire (12 L) avec fixation à la porte du meuble. Soulèvement du couvercle à l'ouverture de la porte grâce à une ficelle.



W. 280
D. 238
H. 315



TOT 12 L



2 min



min 400 mm



Linea di portaposate modulari dotati di **un'aletta di finitura laterale che consente di inserire il portaposate anche in una porzione di cassetto**, offrendo la possibilità di accessorizzare la restante parte di cassetto a piacere.

L'aletta di finitura è stata studiata per creare un effetto di continuità con il cassetto donando un aspetto gradevole e lineare all'insieme. I moduli disponibili consentono di creare numerose varianti di prodotto adattabili a differenti larghezze di cassetto. Combi è resa ancora più funzionale dalla possibilità di accessorizzare i moduli con portacoltelli e tagliere.

Per creare un legame armonioso tra i diversi vani della cucina, il linguaggio estetico della Linea Combi usa le stesse geometrie dei raccoglitori per raccolta differenziata "Sistema 9XL".

Line of modular cutlery trays fitted **with a side wing so that the cutlery tray can even be inserted into a portion of drawer**, giving you the possibility to accessorise the remaining part of the drawer the way you want. The wing has been designed to create a continuity effect with the drawer giving an overall pleasant and linear look. The modules available create numerous variations of product adaptable to different drawer widths. Combi is made even more functional by the possibility to accessorize the modules with knife holders and chopping board.

To create a harmonious connection among the different niches in the kitchen, the aesthetic language of Combi uses the same shapes of the "Sistema 9XL" collectors for separate waste collection.

Ligne de range-couverts modulaires **pourvus d'une ailette de finition latérale qui permet d'insérer le range-couverts également dans une partie du tiroir**, en offrant ainsi la possibilité d'accessoiriser la partie restante à votre convenance. L'ailette de finition a été étudiée pour créer un effet de continuité avec le tiroir tout en conférant un aspect agréable et linéaire à l'ensemble. Les modules disponibles permettent de créer de nombreuses variantes du produit adaptables à différentes largeurs de tiroir. La possibilité d'accessoiriser les modules avec range-couteaux et planche à découper font de Combi une ligne encore plus fonctionnelle.

Pour créer un lien harmonieux entre les différentes parties de la cuisine le langage esthétique de la Ligne Combi utilise les mêmes géométries des récipients pour le tri sélectif "Système 9XL".

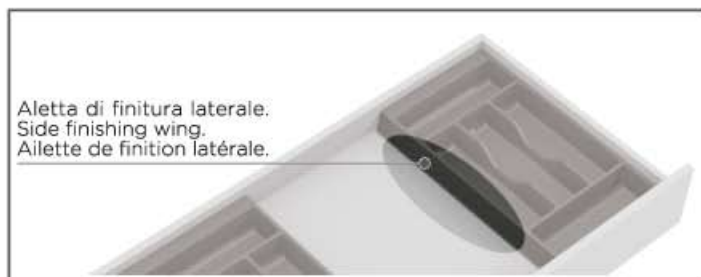

Aletta di finitura laterale.
Side finishing wing.
Ailette de finition latérale.





Colori/Colours/Couleurs:
Grigio orione/Orion grey/Gris orion

Imballo / Packing / Conditionnement
25 pz pcs

Elemento adatto a posizionamento al fianco del cassetto
Element to be positioned on the drawer side / Élément positionnable avec côté du tiroir.

710

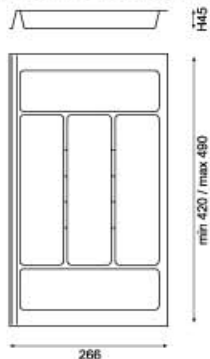

714

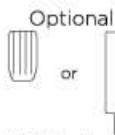
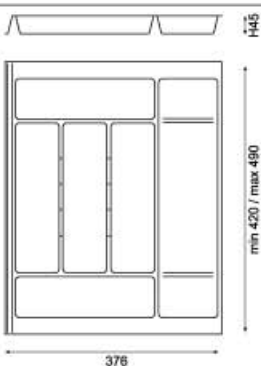

Art. 716 Art. 717

715

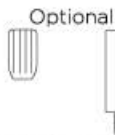
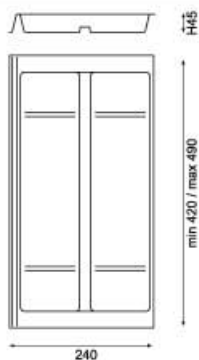

Art. 716 Art. 717

Elemento adatto a posizionamento al centro del cassetto
Element to be positioned in the middle of the drawer / Élément positionnable au centre du tiroir.

712

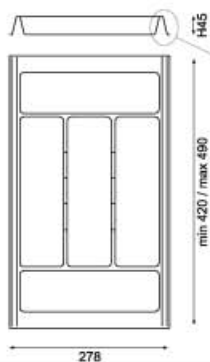

Aletta di finitura laterale presente su entrambi i lati.
Side finishing wing on both sides.
Ailette de finition latérale sur les deux côtés.



716

WOOD



Porta coltelli in faggio
Adatto ad art.
714, 715

Knife block made of beech wood
Suitable for item:
714, 715

Porte-couteaux en hêtre
Indiqué pour les réf.
714, 715

Imballo / Packing / Conditionnement
5 pz pcs

717



Tagliere in polietilene
Adatto ad art.
714, 715

Chopping board made of polyethylene
Suitable for item:
714, 715

Planche à découper en polyéthylène
Indiqué pour les réf.
714, 715

Imballo / Packing / Conditionnement
5 pz pcs





Linea COMBI™

Alcuni esempi di COMBINazioni nei cassetti
Some examples of COMBINations in the drawers
Quelques exemples de COMBINaisons dans les tiroirs

710 



712 



714 

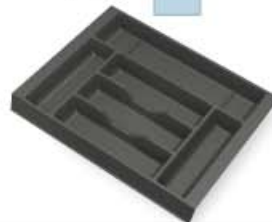

715 



base 400 mm

710



715



base 450 mm

710



715



base 600 mm

714



715

710

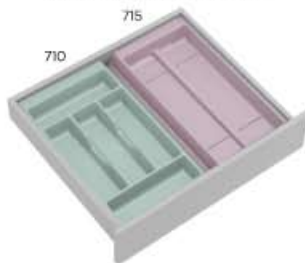

712



base 900 mm

714



715



715



base 1200 mm

714

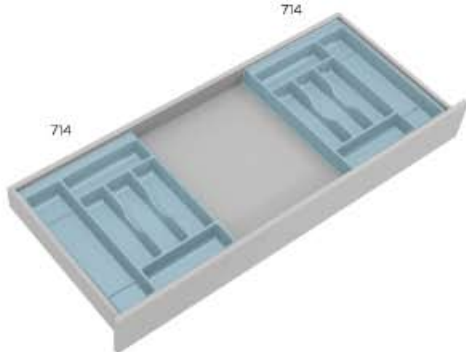

712

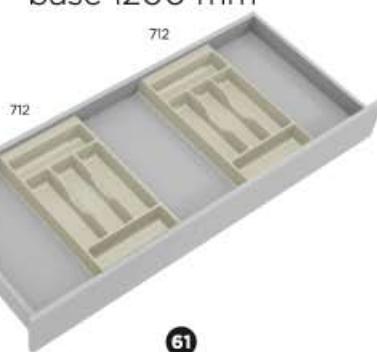

715

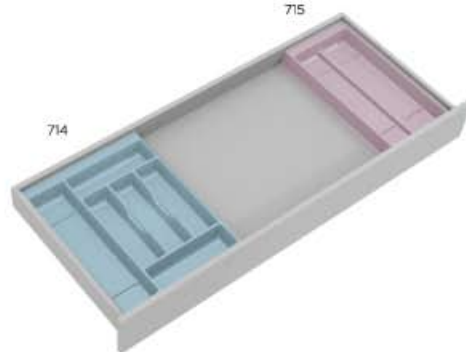



Colori/Colours/Couleurs:
 Bianco / White / Blanc
 Grigio metallizzato / Metallic grey / Gris metallique
 Grigio orione / Orion grey / Gris orion

Forniti a misura (su richiesta)
 Custom size upon request
 Fournis sur mesure (sur demande)



Imballo / Packing / Conditionnement
 25 pz pcs

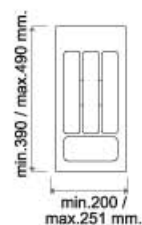

770



300 mm



Imballo / Packing / Conditionnement
 25 pz pcs

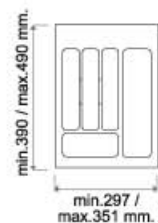

772



400 mm



Imballo / Packing / Conditionnement
 25 pz pcs

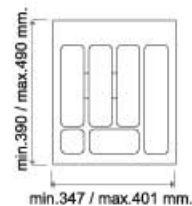

773



450 mm

Optional / en option
 (pag. 67):

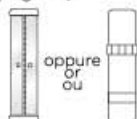

Art. 795 Art. 794



Imballo / Packing / Conditionnement
 20 pz pcs

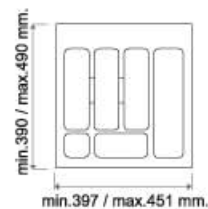

774



500 mm



Linea Classica

Colori/Colours/Couleurs:
 Bianco / White / Blanc
 Grigio metallizzato / Metallic grey / Gris metallique
 Grigio orione / Orion grey / Gris orion

Forniti a misura (su richiesta)
 Custom size upon request
 Fournis sur mesure (sur demande)

776

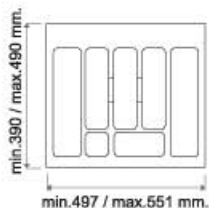

600 mm



Optional / en option (pag. 67):

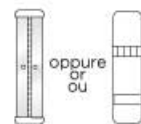

Art. 795 Art. 794

Imballo / Packing / Conditionnement
 20 pz pcs

778

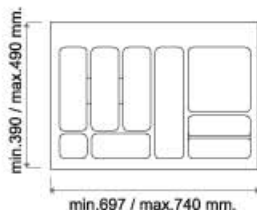

800 mm



Optional / en option (pag. 67):

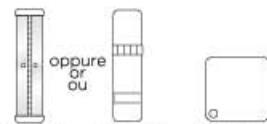

Art. 795 Art. 794 Art. 791

Imballo / Packing / Conditionnement
 10 pz pcs

780

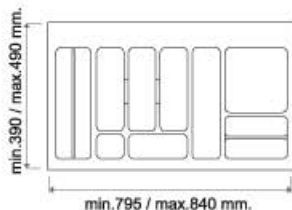

900 mm



Optional / en option (pag. 67):

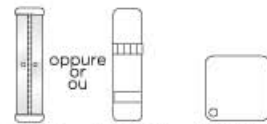

Art. 795 Art. 794 Art. 791

Imballo / Packing / Conditionnement
 10 pz pcs

781

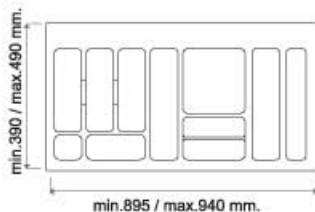

1000 mm



Optional / en option (pag. 67):



Art. 795 Art. 794 Art. 791

Imballo / Packing / Conditionnement
 5 pz pcs

783

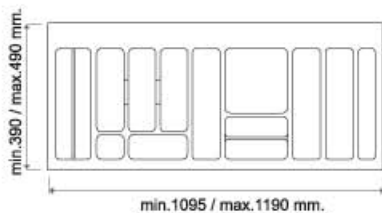

1200 mm

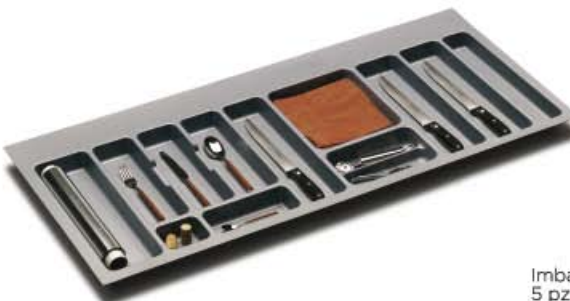

Optional / en option (pag. 67):



Art. 795 Art. 794 Art. 791

Imballo / Packing / Conditionnement
 5 pz pcs



Lucchi & Orlandini Design

Colori/Colours/Couleurs:
Bianco /White / Blanc
Grigio metallizzato / Metallic grey / Gris metallique

Forniti a misura (su richiesta)
Custom size upon request
Fournis sur mesure (sur demande)



738

Imballo / Packing / Conditionnement
25 pz pcs



300 mm

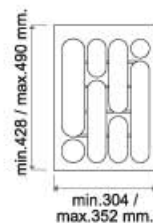

739

Imballo / Packing / Conditionnement
25 pz pcs



400 mm

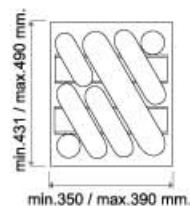

740

Imballo / Packing / Conditionnement
25 pz pcs



450 mm



Colori/Colours/Couleurs:
Bianco / White / Blanc
Grigio metallizzato / Metallic grey / Gris metallique

Forniti a misura (su richiesta)
Custom size upon request
Fournis sur mesure (sur demande)

743

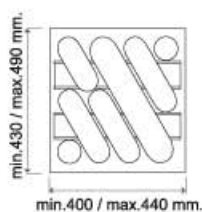

Optional / en option
(pag.67)



Art. 790



500 mm

Imballo / Packing / Conditionnement
20 pz pcs

745

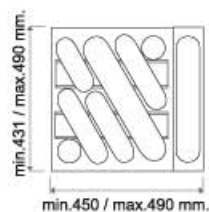

550 mm

Imballo / Packing / Conditionnement
5 pz pcs

741

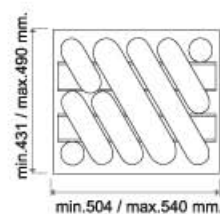

Optional / en option
(pag.67)

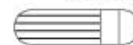

Art. 790



600 mm

Imballo / Packing / Conditionnement
20 pz pcs

747

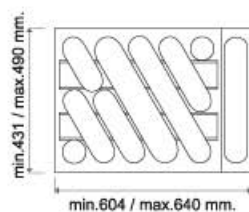

Optional / en option
(pag.67)



Art. 790



700 mm

Imballo / Packing / Conditionnement
5 pz pcs

Colori/Colours/Couleurs:
Bianco / White / Blanc
Grigio metallizzato / Metallic grey / Gris metallique

Forniti a misura (su richiesta)
Custom size upon request
Fournis sur mesure (sur demande)

Optional / en option
(pag.67)



Art. 790

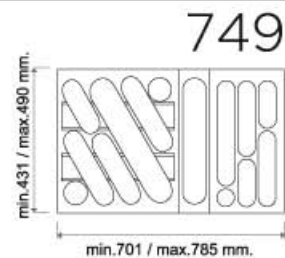

800 mm

Imballo / Packing / Conditionnement
5 pz pcs

Optional / en option
(pag.67)



Art. 790



Art. 791



Art. 792

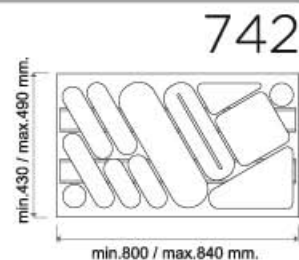

900 mm

Imballo / Packing / Conditionnement
10 pz pcs

Optional / en option
(pag.67)



Art. 790



Art. 791



Art. 792

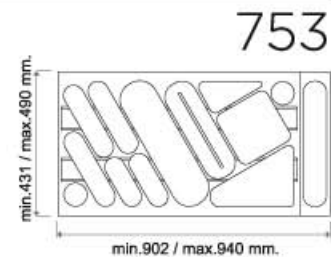

1000 mm

Imballo / Packing / Conditionnement
5 pz pcs

Optional / en option
(pag.67)



Art. 790



Art. 791



Art. 792

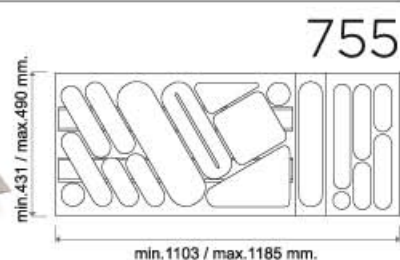

1200 mm

Imballo / Packing / Conditionnement
5 pz pcs



Optionals

790

Porta coltelli in faggio
Adatto ad art.
743, 741, 747, 749, 742, 753, 755

Knife block made of beech wood
Suitable for item:
743, 741, 747, 749, 742, 753, 755

Porte-couteaux en hêtre
Indiqué pour les réf.
743, 741, 747, 749, 742, 753, 755



WOOD

792

Porta spezie in faggio
Adatto ad art.
742, 753, 755

Spice tray made of beech wood
Suitable for item:
742, 753, 755

Porte-épices en hêtre
Indiqué pour les réf.
742, 753, 755



WOOD

791

Tagliere in faggio
Adatto ad art.
2030, 2040, 2050, 742, 753, 755, 778, 780, 781, 783

Chopping board made of beech wood
Suitable for item:
2030, 2040, 2050, 742, 753, 755, 778, 780, 781, 783

Planche à découper en hêtre
Indiqué pour les réf.
2030, 2040, 2050, 742, 753, 755, 778, 780, 781, 783



WOOD

795

Porta pellicole in acciaio inox
Adatto ad art.
774, 776, 778, 780, 781, 783

Film dispenser made of stainless steel
Suitable for item:
774, 776, 778, 780, 781, 783

Porte-rouleaux de film en acier inox
Indiqué pour les réf.
774, 776, 778, 780, 781, 783

Colori/Colours/Couleurs:
Bianco /White / Blanc
Grigio metallizzato / Metallic grey / Gris metallique
Grigio orione / Orion grey / Gris orion



INOX

794

Porta coltelli in faggio
Adatto ad art.
774, 776, 778, 780, 781, 783

Knife block made of beech wood
Suitable for item:
774, 776, 778, 780, 781, 783

Porte-couteaux en hêtre
Indiqué pour les réf.
774, 776, 778, 780, 781, 783



WOOD



Finitura / Finishing / Finition:
Faggio / Beech wood / Bois d'hêtre

Imballo / Packing / Conditionnement
1 pz pc

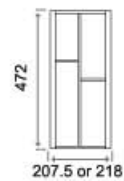

2010



Blum Legrabox®
version



300 mm

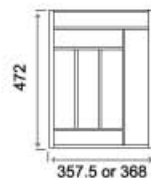

2020



450 mm



Linea Legno

Finitura / Finishing / Finition:
Faggio / Beech wood / Bois d'hêtre

Imballo / Packing / Conditionnement
1 pz pc

2030

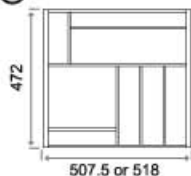

Optional:
Art. **791** (pag. 67)



600 mm

2040

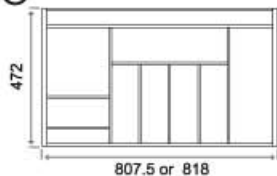

Optional:
Art. **791** (pag. 67)



900 mm

2050

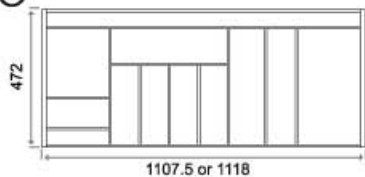

Optional:
Art. **791** (pag. 67)



1200 mm



BATHROOM&LAUNDRY





La Linea ONDA Vanity™ propone vasche dotate di accessori multifunzione removibili. Le vasche sono disponibili in diverse misure per adattarsi alle varie dimensioni dei cassetti.

ONDA Line Vanity™ offers trays supplied with removable multi-function accessories. The trays are available in different sizes to suit the different drawer dimensions.

La Ligne ONDA Vanity™ propose vasques fournies avec accessoires amovibles multifonctionnels. Les vasques sont disponibles en plusieurs tailles pour s'adapter aux différentes dimensions des tiroirs.

Colori/Colours/Couleurs:
Bianco/White/Blanc
Grigio orione/Orion grey/Gris orion

ONDA Vanity™



Scatola porta-fazzoletti
Tissue box
Porte mouchoirs



Scatola porta-oggetti
Storage box
Boîte de rangement



Portacosmetici
Cosmetic holder
Boite range-cosmétiques



Vaschetta
Small tray
Bac porte-objets



Scatolina con coperchio
Small box with lid
Petite boîte avec couvercle

<p>Per Profondità For Drawer Depth Pour Profondeur</p> <p>450 mm</p>	<p>CA45VL</p>	<p>CA45VM</p>	<p>CA45SP</p>
<p>Per Profondità For Drawer Depth Pour Profondeur</p> <p>400 mm</p>	<p>CA40VL</p>	<p>CA40VM</p>	<p>CA40SP</p>
<p>Per Profondità For Drawer Depth Pour Profondeur</p> <p>350 mm</p>	<p>CA35VL</p>	<p>CA35VM</p>	<p>CA35SP</p>
<p>Per Profondità For Drawer Depth Pour Profondeur</p> <p>270 mm</p>	<p>CA27VL</p>	<p>CA27VM</p>	<p>CA27SP</p>

Possano essere forniti a misura (su richiesta) / Customized dimensions on request / Fournis à dimension (sur demande)

ONDA Vanity™

Proposte di utilizzo
Set-up suggestions
Exemples d'emploi

(Profondità 400mm / Drawer Depth 400mm / Profondeur 400mm)

base 600 mm

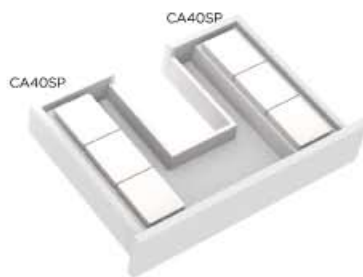

base 800 mm



base 900 mm

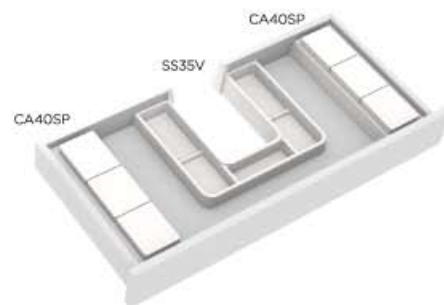

base 1000 mm

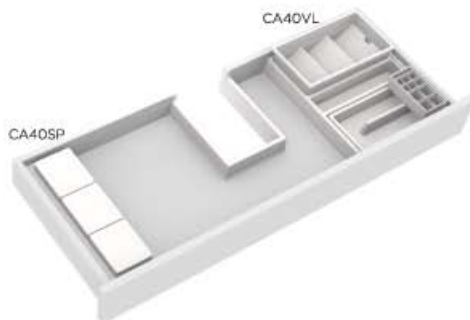

base 1200 mm

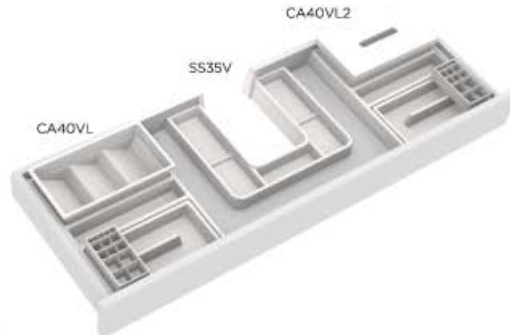

ONDA Vanity Undersink drawer insert



Elemento di protezione in polipropilene per cassetto sotto-lavello. Disponibile in due profondità e dotato di vano portaoggetti laterale/frontale.

Polypropylene protective component for undersink drawer. Available in two depths and equipped with lateral/frontal trays.

Élément de protection en polypropylène pour tiroir sous-évier. Disponible en deux profondeurs et équipé avec vasque frontale/laterale.



Optional:
Portacosmetici
Cosmetic holder
Boîte range-cosmétiques

ONDA Vanity Undersink drawer insert

Colori/Colours/Couleurs:
 Bianco/White/Blanc
 Grigio orione/Orion grey/Gris orion

SS35V

Dimensioni per fondo cassetto
 Drawer base dimensions
 Dimensions du fond tiroir

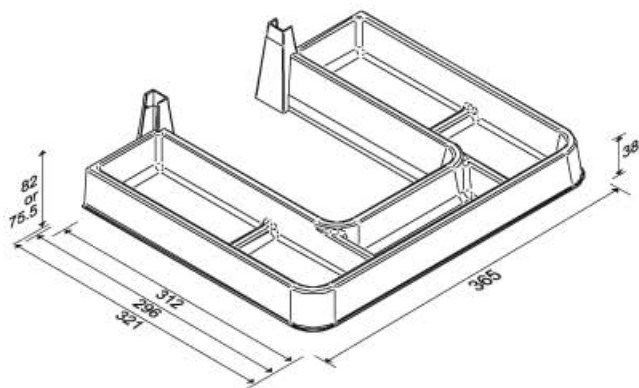
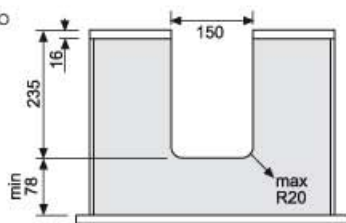

2 min



min 500 mm

Per profondità min.
 For min. drawer depth
 Pour profondeur min.
350 mm

SS27V

Dimensioni per fondo cassetto
 Drawer base dimensions
 Dimensions du fond tiroir

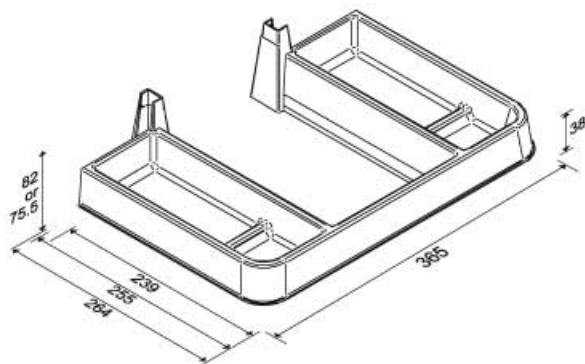
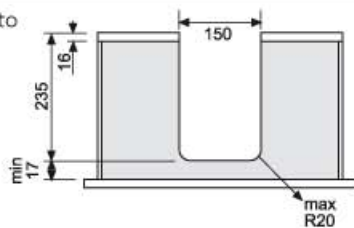

2 min



min 500 mm

Per profondità min.
 For min. drawer depth
 Pour profondeur min.
270 mm

ONDA Undersink drawer insert



Elemento di protezione in polipropilene per cassetto sotto-lavello. Disponibile in due profondità e anche nella versione con vaschetta porta-oggetti.

Polypropylene protective component for undersink drawer. Available in two depths and also in the version with storage tray.

Élément de protection en polypropylène pour tiroir sous-évier. Disponible en deux profondeurs, ainsi que sous la version avec cuvette porte-objets.

Colori/Colours/Couleurs:
Bianco/White/Blanc
Grigio orione/Orion grey/Gris orion

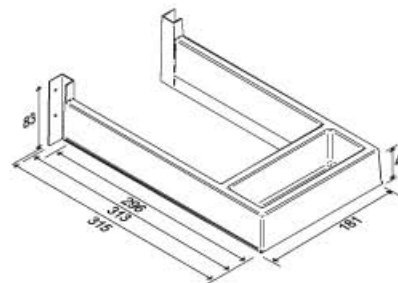
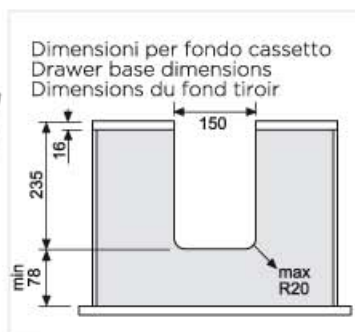

SS35

Per profondità min.
For min. drawer depth
Pour profondeur min.
350 mm

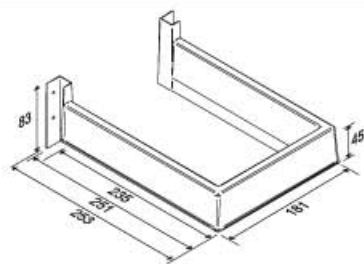
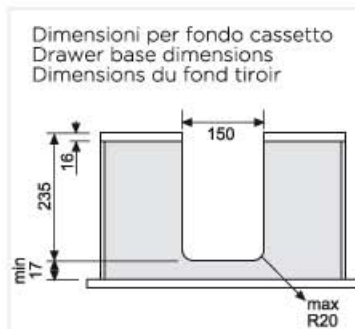

SS27

Per profondità min.
For min. drawer depth
Pour profondeur min.
270 mm

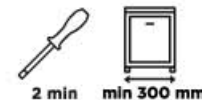

Tappetino antisdrucciolo / Non-slip mat / Tapis anti dérapant

Optional: selezione di tappetini antisdrucciolo in materiale plastico con tessuto centrale auto stendibile.

Optional: selection of non-slip mats in PVC with PES fabric insert.

En option: sélection de tapis antidérapant en matière plastique avec couche centrale en tissu infroissable.

Colori tappetino / Mat Colours / Couleurs tapis:
Grigio / Grey / Gris
Grigio tortora / Dove grey / Gris tourterelle
Grigio antracite / Anthracite grey / Gris anthracite



ONDA BOX



Scatole multi-uso removibili e trasportabili all'esterno del cestone per un pratico uso anche sul top. Le scatole più piccole sono studiate per l'inserimento nella scatola più grande e sono provviste di coperchio portaoggetti.

Multipurpose removable boxes for handy use also on worktops. The smaller boxes are designed to fit inside the largest box and are equipped with a practical storage lid.

Boîtes multi-usages amovibles et transportables à l'extérieur du tiroir pour une utilisation pratique sur le top également. Les boîtes les plus petites ont été conçues pour être introduites dans la boîte plus grande et sont équipées d'un couvercle de rangement pratique.

Colori/Colours/Couleurs:
 Bianco/White/Blanc
 Grigio orione/Orion grey/Gris orion

ONDA BOX

complete box
 W. 254
 D. 254
 H. 210

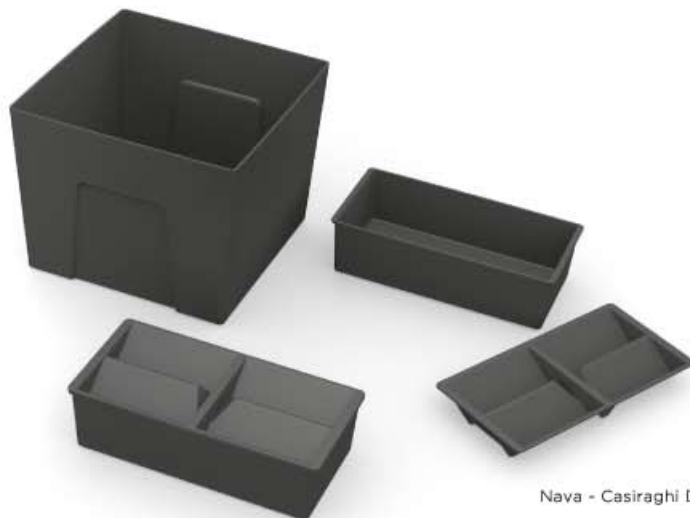
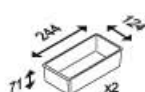
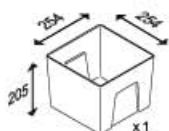

Nava - Casiraghi Design



Colori/Colours/Couleurs:
Bianco/White/Blanc
Grigio orione/Orion grey/Gris orion

Per Profondità
For Drawer Depth
Pour Profondeur
450 mm

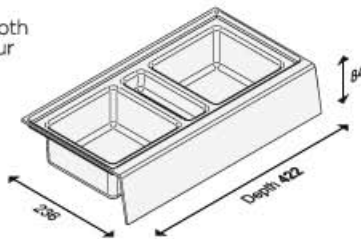

CE45S

Per Profondità
For Drawer Depth
Pour Profondeur
400 mm

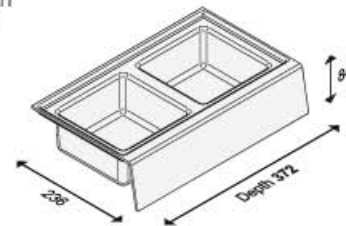

CE40S

Per Profondità
For Drawer Depth
Pour Profondeur
350 mm

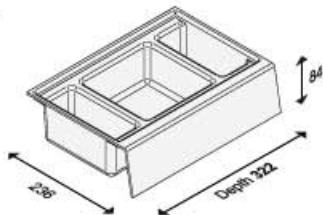

CE35S

Per Profondità
For Drawer Depth
Pour Profondeur
270 mm

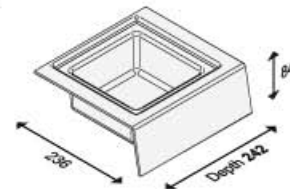

CE27S

Optional: raccogliitore 5 L
Optional: 5-litres bin
En option: boîte à déchets 5 L



Raccoglitore con coperchio / Bin with lid / Boîte à déchets avec couvercle

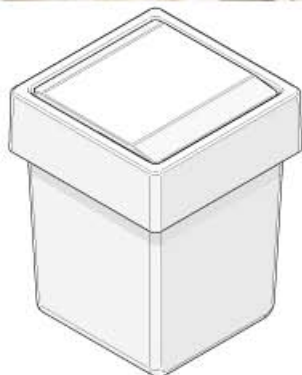

Colori/Colours/Couleurs:
Bianco/White/Blanc
Grigio orione/Orion grey/Gris orion

PATCE

Coperchio basculante
Swivelling lid
Couvercle basculant

W. 174
D. 174
H. 229



TOT 5 L

PATCEB

Coperchio manuale
Manual lid
Couvercle manuel

W. 170
D. 170
H. 202



TOT 5 L



door mounted accessories



Pratico raccoglitore bagno dotato di supporto per fissaggio all'anta. Il prodotto include un kit di montaggio che consente il fissaggio sia con nastro biadesivo che con viti.

Practical bathroom collector with support for door mounting. The product includes a mounting kit that allows the fixation with double-sided tape or with screws.

Collecteur pratique pour la salle de bains avec support pour fixation sur porte. Le produit inclut un kit de montage qui permet à la fois le montage avec ruban adhésif double face ou avec des vis.

Colori/Colours/Couleurs:
Bianco/White/Blanc
Grigio orione/Orion grey/Gris orion

ATANA

Raccoglitore con coperchio basculante.
Bin with swivelling lid.
Boîte à déchets avec couvercle basculant.

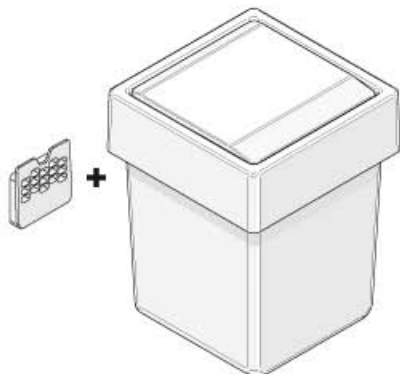

W. 174
D. 176
H. 229



TOT 5 L 2 min

ATANB

Raccoglitore con coperchio manuale.
Bin with manual lid.
Boîte à déchets avec couvercle manuel.

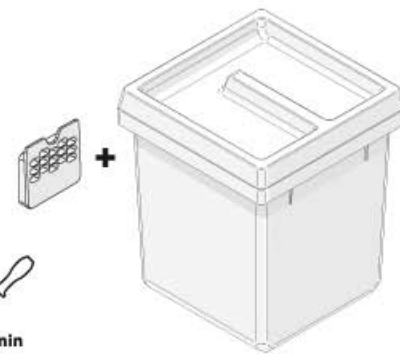

W. 170
D. 174
H. 202



TOT 5 L 2 min

Linea 580 Plus Laundry



- Telaio in metallo con sponde in plastica. Supporti centrali in metallo
- Metal frame with plastic sides. Metal middle brackets
- Cadre en métal avec bords en plastique. Support central en métal

- Adatto a mobili con pareti laterali da 16 a 19mm di spessore
- Suitable for cabinets with sides thickness from 16 to 19mm
- Adapte pour meubles avec épaisseur laterale de 16 à 19mm

- Guide estrazione totale. Chiusura assistita e ammortizzata
- Full extension slides. Assisted and damped closing
- Glissières à sortie totale. Fermeture assistée et amortie

- Ceste dotate di maniglie laterali per facilitare la presa e incavi inferiori per agevolarne lo svuotamento.
- Baskets equipped with side handles for a better grip and lower hollows to facilitate emptying.
- Paniers équipés de poignées latérales pour faciliter la prise et évidements inférieurs pour faciliter les vidanges.

- Versione profondità 450 disponibile su richiesta
- 450 depth version available on request
- Version avec profondeur 450 disponible sur demande

Linea 580 Plus Laundry

Colori / Colours / Couleurs
Bianco / White / Blanc

LAB1580PL60

D. 458
H. 504



10 min



600 mm

SOFT
10 min



80
LITRI

LAB1580PL45

D. 458
H. 504



10 min



450 mm

SOFT
10 min



50
LITRI

Linea 560 Laundry



- Compatibile con sponde da cassetto:
- Available for drawer slides:
- Disponibles pour côtés des tiroirs:

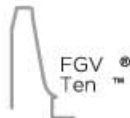

- Adatto a mobili con pareti laterali da 16 a 19mm di spessore
- Suitable for cabinets with sides thickness from 16 to 19mm
- Adapte pour meubles avec épaisseur laterale de 16 à 19mm

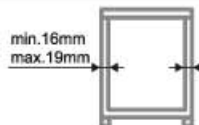

- Telaio in metallo con sponde in plastica
- Metal frame with plastic sides
- Cadre en métal avec bords en plastique

- Ceste dotate di maniglie laterali per facilitare la presa e incavi inferiori per agevolare lo svuotamento.
- Baskets equipped with side handles for a better grip and lower hollows to facilitate emptying.
- Paniers équipés de poignées latérales pour faciliter la prise et évidements inférieurs pour faciliter les vidanges.

Colori / Colours / Couleurs
Bianco / White / Blanc

LAB1560B60



TOT 80 L



10 min



600 mm

D. 473
H. 506

LAB1560B50



TOT 50 L



10 min



500 mm

D. 473
H. 506

(Disponibile anche per cassetti profondità 450mm
Also available for 450mm drawer depth
Aussi disponible pour tiroirs profondeur 450mm

D. 423
H. 506

LAB1560B45



TOT 50 L



10 min



450 mm

D. 473
H. 506

(Disponibile anche per cassetti profondità 450mm
Also available for 450mm drawer depth
Aussi disponible pour tiroirs profondeur 450mm

D. 423
H. 506

LAB1560B40



TOT 40 L



10 min



400 mm

D. 473
H. 506

* Optional:
guide e sponde da cassetto
drawer slides and drawer sides
glissières et côtés pour tiroir

Linea BH Laundry

Soluzioni per mobili con anta a ribalta
Solutions for bottom hinged cabinet
Solutions pour meubles avec porte à abattant



- Dotato di meccanismo di snodo per anta a ribalta frenato in apertura.
- Equipped with tilt out brake in opening mechanism for bottom hinged door.
- Équipé avec mécanisme ouverture compas pour porte à abattant avec frein en ouverture.

Colori / Colours / Couleurs
 Bianco / White / Blanc



In dotazione:
 • supporti in metallo verniciato
 • cesta estraibile
 • meccanismo di snodo

Equipment:
 • painted metal supports
 • removable basket
 • tilt out mechanism

Dotation:
 • supports en métal peint
 • panier amovible
 • mécanisme ouverture compas

LAB1BH1G



TOT 50 L



5 min



min. 450 mm

W. 400
 D. 307
 H. 504



In dotazione:
 • supporti in metallo verniciato
 • cesta estraibile
 • meccanismo di snodo

Equipment:
 • painted metal supports
 • removable basket
 • tilt out mechanism

Dotation:
 • supports en métal peint
 • panier amovible
 • mécanisme ouverture compas

LAB1BH1P



TOT 40 L



5 min



min. 500 mm

W. 438
 D. 222
 H. 504

Linea UP Laundry

fissaggio sottotop
under-top installation
installation sous-comptoir



- Fissaggio alla parte superiore, non necessita di fissaggio ai fianchi del mobile
- Telaio in metallo verniciato
- Guide estrazione totale
- Under-top installation, no cabinet sides needed to install the product
- Painted metal frame
- Full extension slides
- Fixation sous comptoir, pas de nécessité d'installation sur les côtés du meuble
- Cadre en métal peint
- Glissières à sortie totale

Colori / Colours / Couleurs
 Bianco / White / Blanc

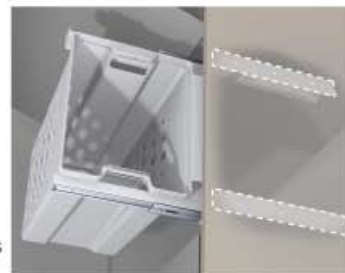

LAB1UPG



TOT 50 L



5 min



min. 500 mm

W. **448**
 D. **352**
 H. 529

LAB1UPP



TOT 40 L



5 min



min. 550 mm

W. **488**
 D. **307**
 H. 529

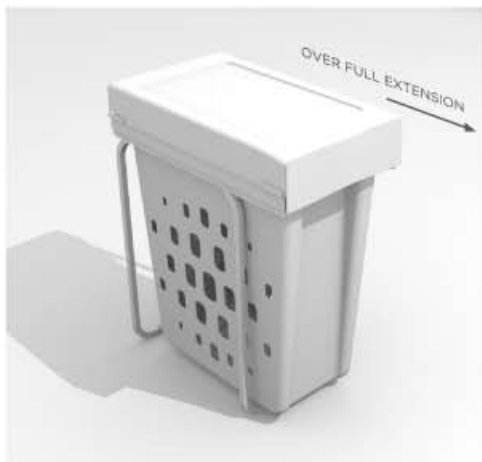

LAB1294

La soluzione ideale per spazi ridotti (base min. **300 mm**).
Dotato di speciali guide ad estrazione totale.
Il coperchio consente l'appoggio di guanti, spugne e piccoli oggetti.

The ideal solution for small spaces (minimum base **300 mm**).
Equipped with special full extension slides.
The lid allows the rest of gloves, sponges and small objects.

La solution idéale pour les espaces réduits (base min. **300 mm**).
Équipé avec spéciales glissières à extraction totale.
Le couvercle permet l'appui de gants, éponges et petits objets.



TOT 40 L



2 min



min. 300 mm

W. 255
D. 450
H. 537

Laundry accessories



Enrico Tommasini Design

LAB1557

Colori/Colours/Couleurs:
Bianco, coperchio grigio fumé
White, smoke grey lid
Blanc, couvercle gris fumé



TOT 5 L

W. 247
D. 185
H. 182



LAB1150

Colori/Colours/Couleurs:
Bianco / White / Blanc

In dotazione 1 vaschetta multiuso
Equipped with 1 multi-use removable tray
En dotation 1 bac amovible tous usages

Posizionabile su base min. **350 mm** in caso di fissaggio per estrazione manuale
Can be fixed into a min. **350 mm** cabinet in case of manual pull-out extraction
Peut être logé dans base min. **350 mm** en cas de fixation pour extraction manuelle



5 min



min 400 mm



automatic

W. 267
D. 440
H. 291

Nell'ottica di offrire un prodotto sempre migliore, Gollinucci s.r.l. a Socio Unico si riserva di modificare alcuni particolari senza preavviso.
In order to allow a constant improvement of the product, Gollinucci s.r.l. a Socio Unico may modify some details without notice.
Afin d'améliorer constamment son produit Gollinucci s.r.l. a Socio Unico en pourra modifier quelques détails sans avis préalable.

Legenda / Legend / Legende

Quantità secchi in dotazione / Supplied bins quantity / Quantité seaux en dotation



Capacità in litri
Capacity in litres
Capacité en litres



Tempo di montaggio
Assembly time
Temps d'assemblage



Mobile base
Cabinet size
Dim. meuble

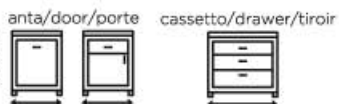

Estrazione automatica
Automatic extraction
Extraction automatique



Numero di vani per raccolta differenziata
Numbers of rooms for separate collection / Nombre de secteurs pour collecte sélective



Dimensioni / Sizes / Dimensions

W. Larghezza / Width / Largeur (mm)
D. Profondità / Depth / Profondeur (mm)
H. Altezza / Height / Hauteur (mm)

Colori / Colours / Couleurs

	Bianco / White / Blanc
	Grigio chiaro / Light grey / Gris clair
	Grigio tortora / Dove grey / Gris tourterelle
	Grigio / Grey / Gris
	Grigio metallizzato / Metallic grey / Gris métallique
	Grigio quarzo / Quartz grey / Gris quartz
	Grigio orione / Orion grey / Gris orion
	Grigio fumé / Smoke grey / Gris fumé
	Nero / Black / Noir
	Verde / Green / Vert

Photography
Marco Onofri
Gianluca Colagrossi

3D Images
Studio Podrini

Printing
Grafiche MDM

Printed in 05_2019

Gollinucci s.r.l. a Socio Unico
Via Dino Rondani, 250
47522 Cesena (FC) Italia
Tel +39 0547 318 234
Fax +39 0547 318 489
C.F. & P.I 02439640406
info@gollinucci.com

www.gollinucci.com



Capezzuoli Rappresentanze s.n.c.

Strada Prov. le 1 per S. Gimignano - Loc. Fosci n. 9

53036 Poggibonsi (SI)

Tel. 0577 992129

capezzuoli@libero.it - info@capezzuoli.com

www.capezzuoli.com