



DAMIANO
[LATINI]

#DamianoLatini
#italiandesign

COLLECTION 2020



DAMIANO
[LATINI]

#DamianoLatini
#italiandesign

C O L L E C T I O N 2 0 2 0

ITALIAN CREATIVE DESIGN

#DamianoLatini
#italiandesign

Venti anni fa, quando la nostra azienda ha iniziato a muovere i primi passi nel mondo delle cucine, non avremmo mai immaginato di crescere così velocemente e di diventare in poco tempo fra i più importanti fornitori di brand nazionali e internazionali. Questo grande successo iniziale ci ha spinto ad espandere progressivamente la produzione in un primo momento limitata alle maniglie, ai sottopensili e ai complementi d'arredo. Ora la nostra missione è creare soluzioni di arredo personalizzabili e dal design contemporaneo frutto della collaborazione di professionisti italiani e stranieri. Ogni nostro prodotto è realizzato per darti la possibilità di progettare e arredare qualsiasi ambiente seguendo la tua personalità, le tue necessità e il tuo stile, in modo semplice e funzionale. Il tuo spazio abitativo, i gesti quotidiani, le differenti esigenze legate alle tue abitudini sono da sempre ciò che ci spinge ad immaginare nuove creazioni.

Our company was founded twenty years ago and soon established itself as a main handles supplier for kitchen industry in Italy and abroad. The initial success and a revolutionary vision of space, led us to expand our activity to design more and more innovative furnishing solutions to meet our customers changing needs. We design modern cutting-edge furnishing accessories and kitchen racks. All our structures and bookcases are fully customisable, multifunctional and suitable to various environments. As we are, each of us, a little universe, the place where we live reflects our personality too and therefor unique.

20 лет назад, когда наша компания совершала первые шаги в мире кухонь, мы никогда не думали, что в скором времени станем одним из лидирующих поставщиков национальных и международных брендов кухонь. Помимо производства ручек, мы добавили производство рейлинговых систем и мебельных аксессуаров, которые стали нашей гордостью благодаря креативности, функциональности и инновационному дизайну. Ваше жилое пространство, повседневные жесты, разные требования из-за привычек и характеров каждого, это то, что всегда толкает на создание новых творений, тем временем, когда некоторые из них уже, возможно, стали частью Вашей жизни, а вы даже этого не знали. Каждый продукт создается, чтобы дать возможность спроектировать и обустроить любое помещение в простой и функциональный способ. Формы, цвета и материалы являются инструментами, которые компания использует, чтобы создавать оригинальные комбинации и инновационные решения

CREATIVE TEAM



DAMIANO LATINI
Via Sandro Pertini, 63812 - Montegranaro (FM) Italy
T +39 0734 894144 - info@damianolatini.it
www.damianolatini.it

CREATIVE COMBOS

Soluzioni adeguabili ad ogni ambiente e ad ogni necessità. Ogni nostro prodotto nasce per darti la possibilità di progettare e arredare qualsiasi ambiente seguendo le tue idee e il tuo stile, in modo semplice e funzionale. Forme, colori e materiali sono i nostri strumenti per creare combinazioni originali e soluzioni innovative che si adattino a te, ridisegnando i contorni della tua quotidianità. Sempre nuovo pur rimanendo lo stesso: è così che il tuo spazio vitale, la tua casa, il tuo ufficio, cambieranno con te e con l'evoluzione della tua storia personale in un numero di composizioni potenzialmente infinito.

All our products are created to enable you to design and furnish any space in a easy and functional way, following your ideas and style. Shapes, colours and materials are our tools to create unique bespoke furnishing compositions and cutting edge solutions to best suit you. Your places, your home, your office will never be the same, endlessly changing with you and the evolution of your personal life.

Адаптируемые решения для любой среды и любых потребностей. Каждый из наших продуктов создан для того, чтобы дать Вам возможность проектировать и обставлять любую среду в соответствии с вашими идеями и вашим стилем, простым и функциональным способом. Формы, цвета и материалы - наши инструменты для создания оригинальных комбинаций и инновационных решений, которые адаптируются к вам, изменяя контуры Вашей повседневной жизни. Всегда новое, оставаясь неизменным: вот какое Ваше жизненное пространство, Ваш дом, Ваш офис будут меняться вместе с Вами и с развитием Вашей личной истории в потенциально бесконечном количестве композиций

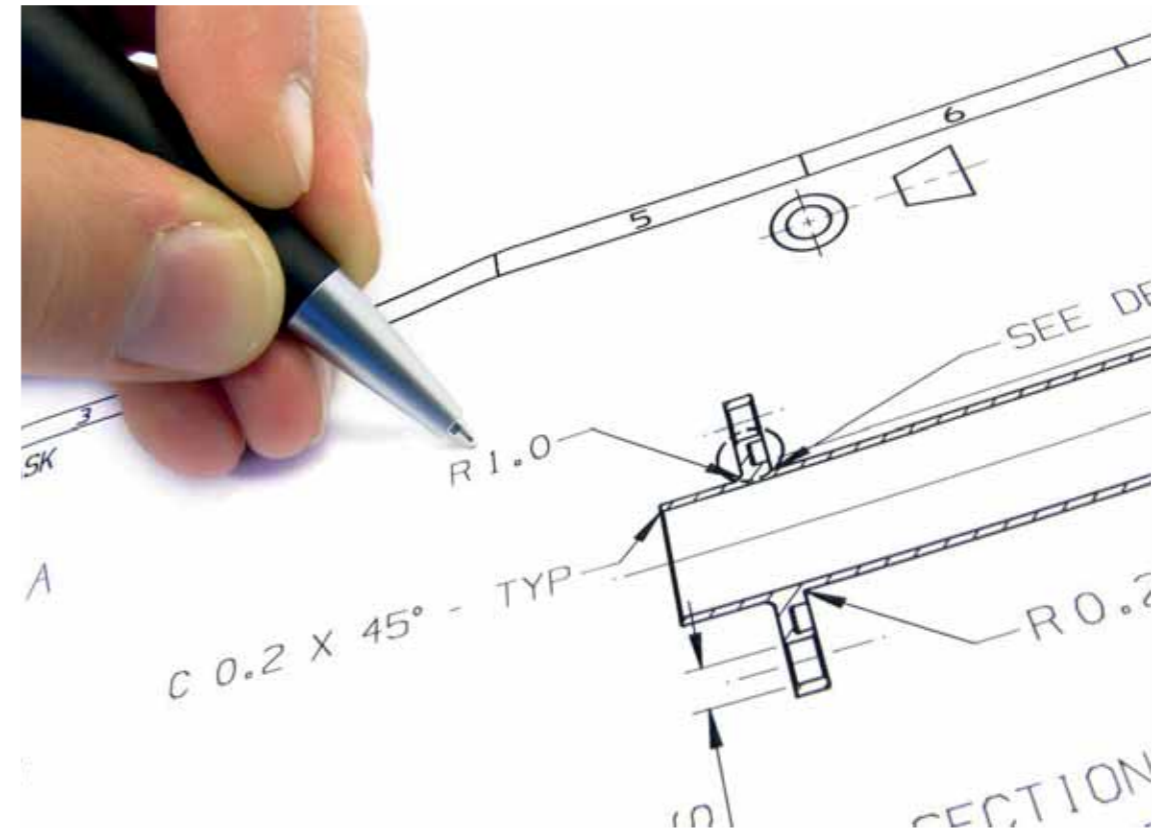

INDICE INDEX ОГЛАВЛЕНИЕ

Collection 2020

10/17	GIOSTRA
18/27	VERTICAL LINE
28/37	GIOSTRA L
38/43	OUTLINE
44/55	DAMA
56/61	STEP
62/71	DAMA L
72/79	GRID
80/87	HANG
88/93	UP
94/101	BACK
102/107	PIPE
108/115	SHELL
116/123	TOWER
124/129	CAOS
130/135	TRIGA
136/141	TRIGA SLIM
142/147	PRATIKA
148/153	COMPACT
154/159	MONDRIAN
160/165	FIRKANT
166/171	HORIZON
172/177	HORIZON BIG
178/183	RISE
184/201	ACCESSORI

GIOSTRA

Lineare, funzionale, pratica. Giostra è una struttura di alluminio componibile, quanto di meglio si possa desiderare per dividere gli spazi in modo bello e razionale. Applicabile semplicemente tra pavimento e soffitto, consente di creare differenti ambienti senza chiudere la vista. Con il suo design leggero e moderno si integra perfettamente a qualsiasi ambiente, domestico o lavorativo, rendendolo più funzionale senza alterarne radicalmente la struttura.

Linear, functional, handy. Giostra is a modular structure made of aluminium, the best way to nicely and rationally divide open spaces. It is easy to attach to the floor and ceiling and it allows you to create multiple rooms without obstructing the view. Thanks to its lightweight and modern design, it fits perfectly into any space, either at home or at work, making the room extremely more functional without altering the structure.

Джостра - линейная, функциональная и практичная, структура из алюминиевых компонуемых профилей. Что можно желать лучшего для разделения пространства в красивой и рациональной форме? Ее простая установка между полом и потолком, позволяет создать разные помещения, не закрывая при этом вид. Легкий и современный дизайн дополняет любые, домашние или рабочие комнаты, не внося радикальных изменений в интерьер



AWARD 2017
Shortlisted





GIOSTRA 90/180/180S/270

Materiale / Materials / МАТЕРИАЛ
Alluminio / Aluminium / Алюминий

	GIOSTRA/90	GIOSTRA/180	GIOSTRA/180S	GIOSTRA/270
Kg.	15.0	24.0	24.0	36.0
L cm	102.8	195.6	195.6	285.6
L1 cm	90.0	90.0	90.0	90.0
H cm (min-max)	266.0 - 276.0	266.0 - 276.0	266.0 - 276.0	266.0 - 276.0
P cm	10.0	10.0	10.0	10.0
X1 cm (min-max)	60.0 - 65.0	60.0 - 65.0	60.0 - 65.0	60.0 - 65.0
X2 cm	50.0	50.0	50.0	50.0
X3 cm (min-max)	-	-	35.4 - 40.4	-

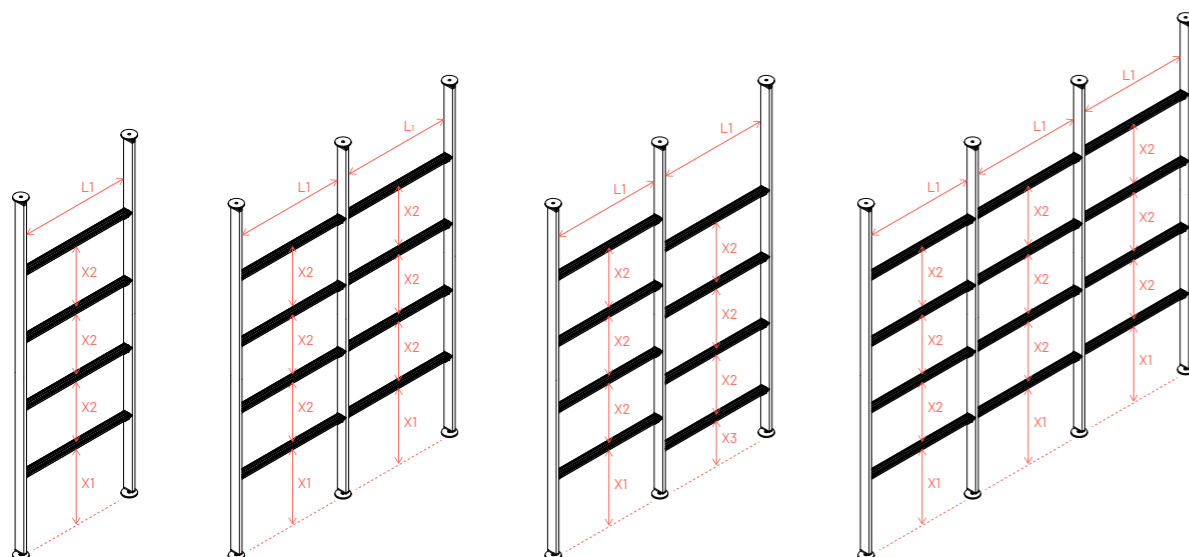

Giostra è un complemento per interni con dimensioni e misure diverse, che possono variare per adeguarsi alla perfezione a tutti i contesti dove l'impianto viene realizzato. Per questo, Giostra è adatto a edifici residenziali, uffici, centri commerciali perché il cliente può individuare la tipologia che più gli aggrada, con tutte le caratteristiche che desidera e richiede. Si possono avere maggiori informazioni mettendosi in contatto con l'azienda, per telefono o via posta elettronica.

Giostra is a furnishing accessory available in different sizes and shapes to provide you with a bespoke solution that perfectly fit in your space. For this reason, Giostra is suitable for residential buildings, offices and shopping malls. Every customer can choose the favourite structure and add the desired features on demand. For more information please contact the company, by phone or e-mail.

Джостра это дополнение к интерьеру разных размеров и высот, которые могут варьироваться, чтобы идеально подойти в любой контекст, в котором будут установлены. Джостра подходит для жилых помещений, офисов или торговых центров, позволяя клиенту подобрать нужный для него тип, со всеми необходимыми и желаемыми характеристиками. За дополнительной информацией обращайтесь в компанию по телефону или по электронной почте.

FINITURE / FINISHES / Покрытие

- Ghisa / Cast iron / чугу́н
- Titanio / Titanium / титан
- Nero / Black / черный

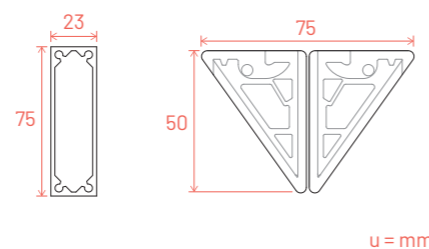

u = mm



PIEDINI DI REGOLAZIONE

Grazie ai piedini di regolazione i montanti possono essere allineati e messi in tensione in modo solido e sicuro in tutta semplicità. Utilizzando i piedini di regolazione è possibile regolare l'altezza fino a 10 cm (5 cm in alto e 5 cm in basso).

ADJUSTING FEET

Thanks to the adjusting feet, you can easily align the pillars in a solid and safe manner. Using the adjustment feet you can adjust the height up to 10 cm (5 cm upward and 5 cm downward).

РЕГУЛИРУЕМЫЕ НОЖКИ

Благодаря регулируемым ножкам, несущие колонны будут выровнены, прочно и надежно отрегулированы простым способом. Ими можно скорректировать высоту до 10 см (5 см снизу и 5 см сверху).

INCASTRO BREVETTATO

La perfetta geometria ed il millimetrico dimensionamento dell'incastro permette di avere una solida tenuta (fino a 40 Kg per ogni barra orizzontale). L'innovativo sistema ad incastro, elimina la necessità di avvitare gli accessori alla struttura, garantendo velocità di montaggio e stabilità.

PATENTED JOINT

Perfect geometry and millimeter sizing of the joint allows for a solid endurance (up to 40 Kg for each horizontal bar). The innovative interlocking system eliminates the need for screwing the accessories to the frame ensuring a quick assembly and solidity.

ЗАПАТЕНТОВАННАЯ СИСТЕМА КРЕПЛЕНИЯ

Идеальная геометрия и точность паза до миллиметров, позволяет получить прочную устойчивость (каждая горизонтальная планка выдерживает до 40 кг). Инновационная система крепления защелкивания в паз, убирает необходимость иметь дополнительные крепежные элементы, но гарантирует скорость монтажа и стабильность структуры.

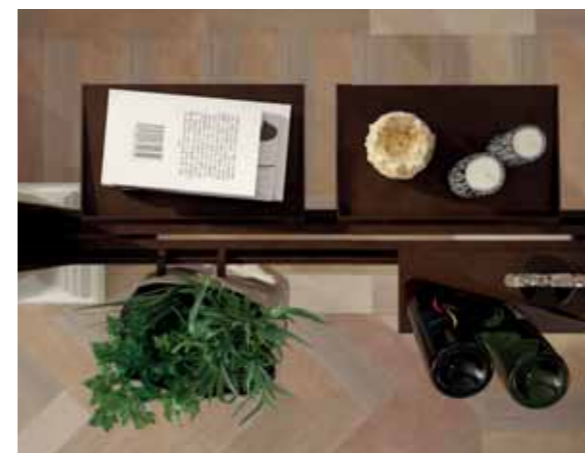

UTILITÀ BIFACCIALE

Grazie alle due barre orizzontali fissate sul montante verticale, Giostra è in grado di formulare molteplici soluzioni per la definizione architettonica degli ambienti. Con una sola struttura è possibile attrezzare due zone distinte, mantenendo sempre un design leggero e moderno.

TWO-SIDED UTILITY

Thanks to the two horizontal bars fixed to the vertical pillar, Giostra can offer multiple solutions for the architectural definition of the spaces. Just one single structure can furnish two distinct areas and yet keep a modern and smart design.

ДВУХСТОРОННЯЯ СИСТЕМА

Благодаря двум горизонтальным планкам, соединенные и зафиксированы на вертикальных несущих колоннах, Джостра может предложить многочисленные решения для определения архитектурных требований к помещению. Всего одна структура может оборудовать две разные зоны, сохраняя легкий и современный дизайн.

MODULARE

Una semplicità architettonica che assicura al progetto un'eccezionale versatilità, con la possibilità di realizzare composizioni anche di ampie dimensioni, in assoluta sicurezza. Affiancando più moduli è possibile comporre infinite soluzioni.

MODULAR



An architectural simplicity that assures the project an exceptional versatility, with the opportunity of creating compositions of even greater dimensions, in absolute safety. By joining multiple modules, it is possible to make infinite solutions.

МОДУЛЬНАЯ КОНСТРУКЦИЯ

Архитектурная простота, которая дарит исключительную многогранность системе, и дает возможность создавать даже большие структуры в полной безопасности. Соединяя дополнительные модули системы, можно создать бесконечное количество решений.

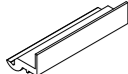
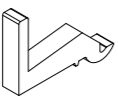
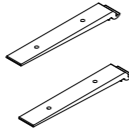
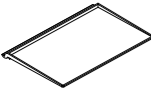

Accessori / Accessories / Аксессуары

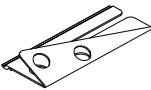
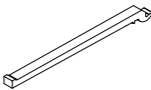
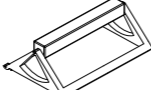
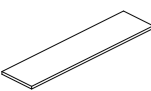
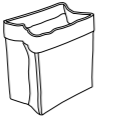
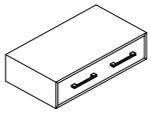
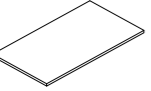
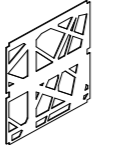
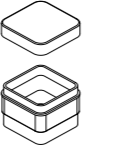
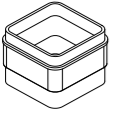
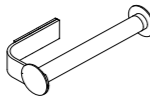
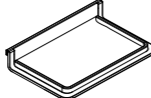
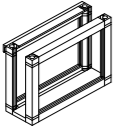
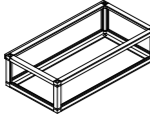
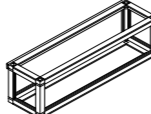
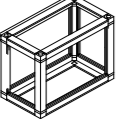
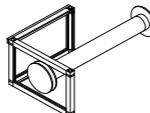
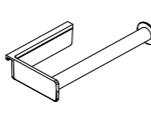
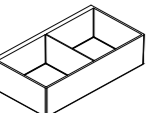
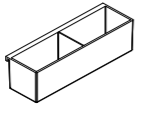
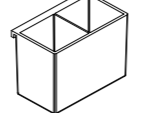
 Adattatore Adapter адаптор pagina 195	 Gancio Hook крючок pagina 194	 Reggimensola Shelf support полкодержатель pagina 194	
 Mensola 270 Shelf 270 полка 270 pagina 192	 Mensola 450 Shelf 450 полка 450 pagina 192	 Mensola 600 Shelf 600 полка 600 pagina 192	
 Portabottiglie Bottle holder держатель для бутылок pagina 195	 Portapentole Pots hook держатель для кастрюль pagina 193	 Portarotolo Roll holder держатель для бумажного полотенца pagina 193	
 Mensola legno 22 Wooden shelf 22 деревянная полка 22 pagina 196	 Sacchetti contenitori Container bags контейнеры pagina 199	 Cassettiera Drawer ящик pagina 197	
 Mensola legno 50 Wooden shelf 50 деревянная полка 50 pagina 196	 Pannello ragnatela Web panel панель pagina 198	 Contenitori Containers контейнеры pagina 188	
 Contenitori Containers контейнеры pagina 188	 Portarotolo Roll holder держатель для бумажного полотенца pagina 189	 Mensola Shelf полка pagina 188	
 Portatovaglioli Napkins holder держатель для салфеток pagina 191	 Portabarattoli Jars holder держатель для баночек pagina 190	 Portaspezie Spices holder держатель для специй pagina 190	
 Portaposate Cutlery holder держатель для столовых приборов pagina 190	 Portarotolo Roll holder держатель для бумажного полотенца pagina 191	 Portarotolo Roll holder держатель для бумажного полотенца pagina 187	
 Portabarattoli Jars holder держатель для баночек pagina 186	 Portaspezie Spices holder держатель для специй pagina 186	 Portaposate Cutlery holder держатель для столовых приборов pagina 186	

○ Abbinare un accessorio ad un adattatore
Match an accessory to an adapter
Использовать один адаптор для крепления
контейнера

○ Abbinare due ganci ad un sacchetto
contentitore
Match two hooks to a container bag
Использовать два крючка для
бумажного мешка – контейнера

○ Abbinare una coppia di staffe reggi-
mensola alla mensola
Match a pair of brackets to the shelf
Использовать пару полкодержателей
для одной полки

○ Abbinare due coppie di staffe reggi-
mensola alla mensola
Match two pairs of brackets to the
shelf
Использовать две пары
полкодержателей для полки



VERTICAL LINE

Vertical line è una struttura di alluminio componibile e bifacciale, costituita da sottili profili in metallo ed intervallata da mensole in legno. Appoggiata al soffitto e al pavimento, funge da elegante divisorio tra la cucina e il living, creando un filtro permeabile tra i diversi ambienti. La sua versatilità le permette di essere utilizzata anche come divisorio tra lo spazio giorno e notte e il design moderno e minimale si adatta a tutti i contesti, sia lavorativi che domestici.

Vertical line is a modular and bifacial frame made of thin metal profiles and interspersed with wooden shelves. It is fixed to the ceiling and the floor. It acts as an elegant partition between the kitchen and the living room, creating a permeable filter between the different rooms. Its versatility allows it to be also used as a partition between living and night spaces, while the modern and minimal design is suitable for all contexts, both working and domestic.

Вертикал лайн - представляет собой двухстороннюю модульную алюминиевую конструкцию, выполненную из тонких металлических профилей и чередующуюся с деревянными полками. Опираясь на потолок и пол, он действует как элегантная перегородка между кухней и гостиной, создавая проницаемый фильтр между разными комнатами. Его универсальность позволяет использовать его также как раздел между дневным и ночным пространством, а современный и минимальный дизайн подходит для всех контекстов, как рабочих, так и домашних





VERTICAL LINE-H238



Materiale / Materials / МАТЕРИАЛ
Alluminio / Aluminium / Алюминий

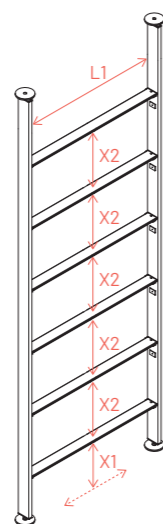

	238 x 600	238 x 900	238 x 1200
Kg.	12.2	14.0	15.8
L cm	72.8	102.8	132.8
L1 cm	60.0	90.0	120.0
H cm (min-max)	238.0 - 248.0	238.0 - 248.0	238.0 - 248.0
P cm	10.0	10.0	10.0
X1 cm (min-max)	23.3 - 29.3	23.3 - 29.3	23.3 - 29.3
X2 cm	38.7	38.7	38.7



FINITURE / FINISHES / Покрытие

-  Ghisa / Cast iron / чугун
-  Titanio / Titanium / титан
-  Nero / Black / черный

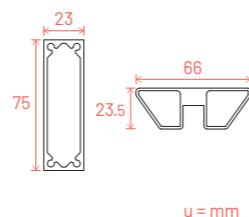

VERTICAL LINE-H268



Materiale / Materials / МАТЕРИАЛ
Alluminio / Aluminium / Алюминий

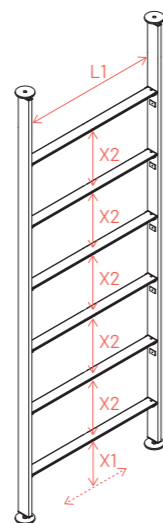

	268 x 600	268 x 900	268 x 1200
Kg.	12.7	14.5	16.3
L cm	72.8	102.8	132.8
L1 cm	60.0	90.0	120.0
H cm (min-max)	268.0 - 278.0	268.0 - 278.0	268.0 - 278.0
P cm	29.7	29.7	29.7
X1 cm (min-max)	23.3 - 29.3	23.3 - 29.3	23.3 - 29.3
X2 cm	38.7	38.7	38.7



FINITURE / FINISHES / Покрытие

-  Ghisa / Cast iron / чугун
-  Titanio / Titanium / титан
-  Nero / Black / черный

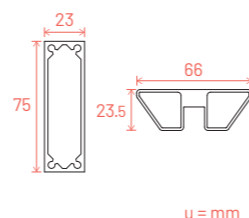

VERTICAL LINE-H288



Materiale / Materials / МАТЕРИАЛ
Alluminio / Aluminium / Алюминий

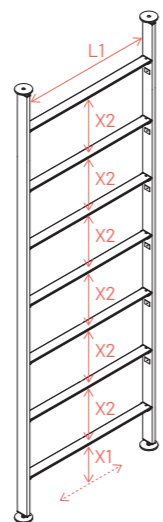

	288 x 600	288 x 900	288 x 1200
Kg.	14.2	16.0	17.8
L cm	72.8	102.8	132.8
L1 cm	60.0	90.0	120.0
H cm (min-max)	288.0 - 298.0	288.0 - 298.0	288.0 - 298.0
P cm	10.0	10.0	10.0
X1 cm (min-max)	28.3 - 34.3	28.3 - 34.3	28.3 - 34.3
X2 cm	38.7	38.7	38.7







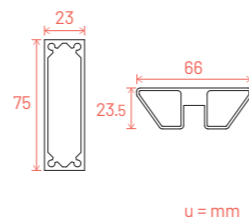



FINITURE / FINISHES / Покрытие

-  Ghisa / Cast iron / чугун
-  Titanio / Titanium / титан
-  Nero / Black / черный

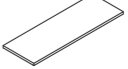

Accessori / Accessories / Аксессуары

	Mensola Shelf полка pagina 198		Mensola Shelf полка pagina 198		Mensola Shelf полка pagina 198
	Pensile Cabinet подвесной ящик pagina 197		Pensile Cabinet подвесной ящик pagina 197		Pensile Cabinet подвесной ящик pagina 197
	Mensola legno 60 Wooden shelf 60 деревянная полка 60 pagina 196		Mensola legno 90 Wooden shelf 90 деревянная полка 90 pagina 196		Mensola legno 120 Wooden shelf 120 деревянная полка 120 pagina 196

Schema composizioni / Configuration / Схема композиции

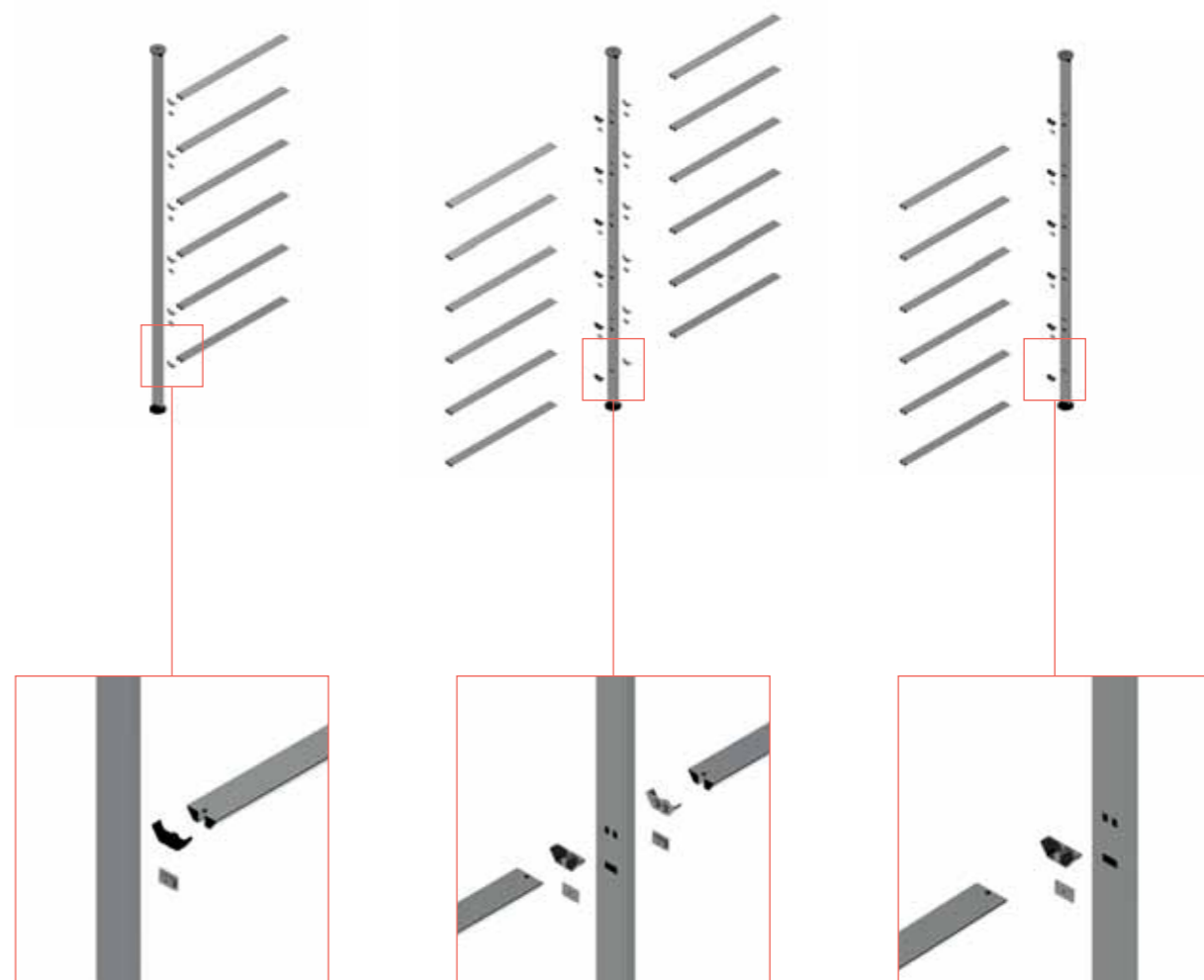



VERTICAL LINE LUX

Materiale / Materials / МАТЕРИАЛ
Alluminio / Aluminium / Алюминий



	268 x 600	268 x 900	268 x 1200
Kg.	12.7	14.5	16.3
L cm	72.8	102.8	132.8
L1 cm	60.0	90.0	120.0
H cm (min-max)	268.0 - 278.0	268.0 - 278.0	268.0 - 278.0
P cm	29.7	29.7	29.7
X1 cm (min-max)	23.3 - 29.3	23.3 - 29.3	23.3 - 29.3
X2 cm	38.7	38.7	38.7

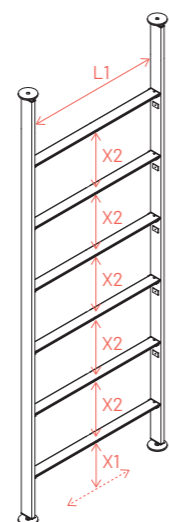

FINITURE / FINISHES / Покрытие

- Ghisa / Cast iron / чугуn
- Titanio / Titanium / титан
- Nero / Black / черный

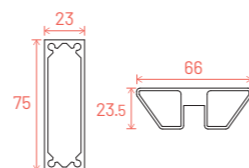

u = mm



ILLUMINAZIONE

Le nostre illuminazioni integrate da collocare sotto alla traversa orizzontale donano atmosfera, funzionalità e stile. I LED non solo consentono di risparmiare energia, ma grazie a un'illuminazione diffusa, contribuiscono a creare un ambiente rilassato e accogliente.

LIGHTENING

Our integrated lighting to be placed under the horizontal crossbar enhance our furniture features making them extremely stylish and functional. LED lighting is not only the most energy efficient option on the market but, thanks to light diffusion, it also helps to create a relaxing and pleasant ambience.

ОСВЕЩЕНИЕ

Наше встроенное освещение, размещаемое под горизонтальной перекладиной, создает атмосферу, функциональность и стиль. Светодиоды не только экономят энергию, но благодаря рассеянному освещению они помогают создать расслабленную и уютную обстановку.

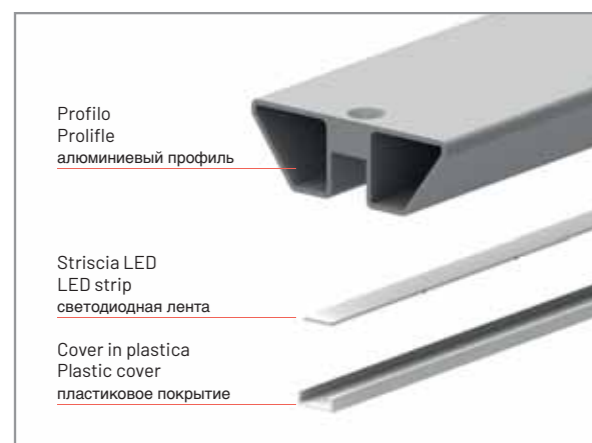

Accessori / Accessories / Аксессуары

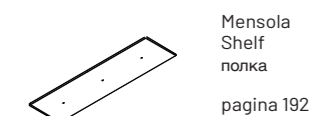
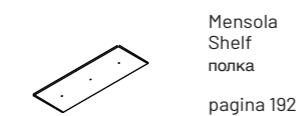
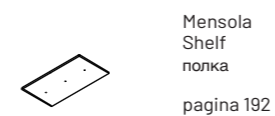

Schema composizioni / Configuration / Схема композиции

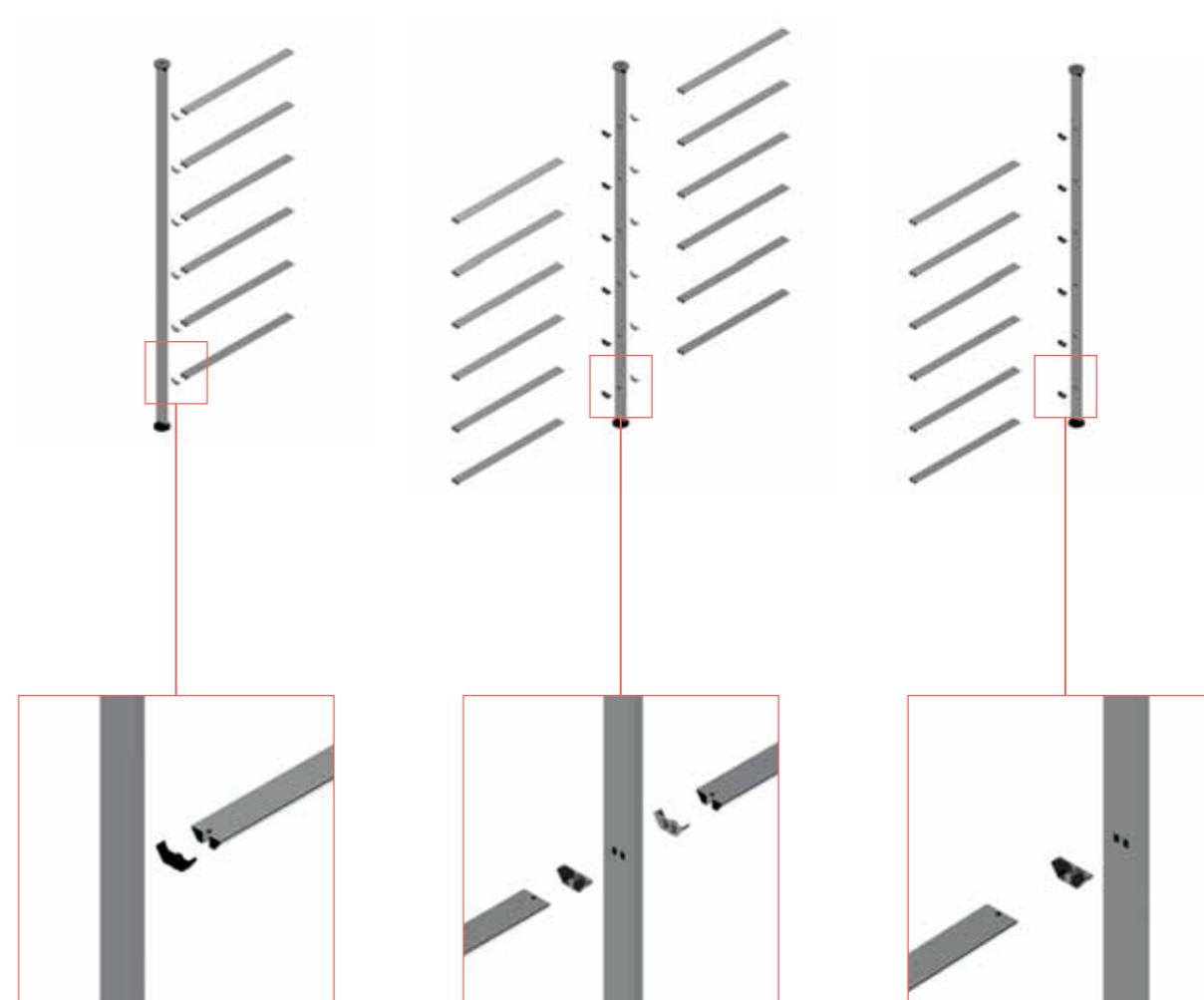

GIOSTRA L

Organizzare lo spazio con eleganza e, nel contempo, secondo criteri di efficienza: questa è, in sintesi, Giostra L. I moduli, disponibili di serie in 3 larghezze, con possibilità di tagli a misura, per garantire al sistema massima flessibilità. Le mensole hanno due tipologie materiale: in legno o in acciaio, è possibile attrezzarla con pensili così da organizzare al meglio gli spazi per ogni ambiente.

How to arrange your space in a sophisticated and efficient way? Giostra L is the answer. The modules are available in 3 different widths, with the possibility of custom cuts to maximize the flexibility of the system. The shelves are available in two materials: wood or steel, it is possible to equip it with hangings to best arrange spaces in each room.

Джостра Эль элегантно и эффективно организует помещение. Модули доступны в 3 размерах, с возможностью резать их под нужный размер, чем гарантируют максимальную гибкость системы. Полки доступны в двух материалах – дерево или сталь, а также возможно дополнить систему ящиками, для лучшей организации пространства



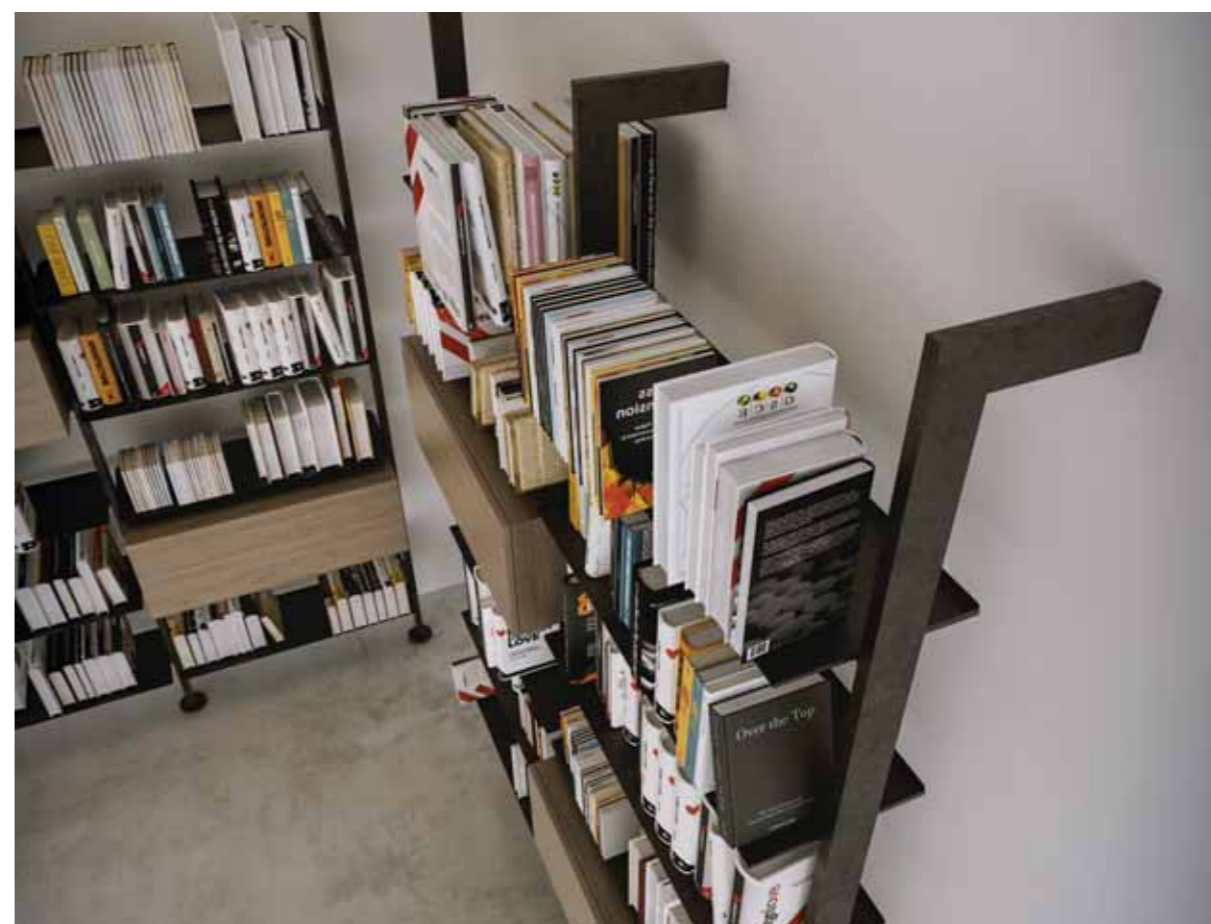

GIOSTRA L - H208

Materiale / Materials / МАТЕРИАЛ
Alluminio / Aluminium / Алюминий



	208 x 600	208 x 900	208 x 1200
Kg.	11.2	13.0	14.8
L cm	72.8	102.8	132.8
L1 cm	60.0	90.0	120.0
H cm (min-max)	208.0 - 214.0	208.0 - 214.0	208.0 - 214.0
P cm	29.7	29.7	29.7
X1 cm (min-max)	28.3 - 34.3	28.3 - 34.3	28.3 - 34.3
X2 cm	38.7	38.7	38.7

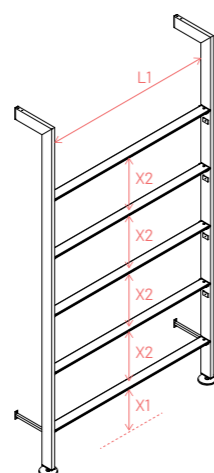

FINITURE / FINISHES / Покрытие

- Ghisa / Cast iron / чугун
- Titanio / Titanium / титан
- Nero / Black / черный

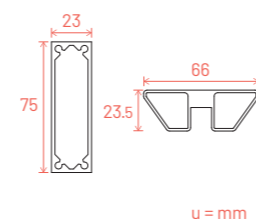

GIOSTRA L - H238

Materiale / Materials / МАТЕРИАЛ
Alluminio / Aluminium / Алюминий



	238 x 600	238 x 900	238 x 1200
Kg.	12.2	14.0	15.8
L cm	72.8	102.8	132.8
L1 cm	60.0	90.0	120.0
H cm (min-max)	238.0 - 244.0	238.0 - 244.0	238.0 - 244.0
P cm	29.7	29.7	29.7
X1 cm (min-max)	23.3 - 29.3	23.3 - 29.3	23.3 - 29.3
X2 cm	38.7	38.7	38.7

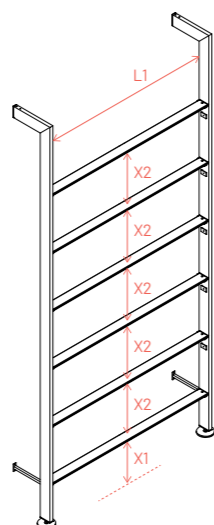

FINITURE / FINISHES / Покрытие

- Ghisa / Cast iron / чугун
- Titanio / Titanium / титан
- Nero / Black / черный

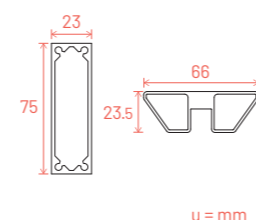

GIOSTRA L - H268

Materiale / Materials / МАТЕРИАЛ
Alluminio / Aluminium / Алюминий



	268 x 600	268 x 900	268 x 1200
Kg.	12.7	14.5	16.3
L cm	72.8	102.8	132.8
L1 cm	60.0	90.0	120.0
H cm (min-max)	268.0 - 274.0	268.0 - 274.0	268.0 - 274.0
P cm	29.7	29.7	29.7
X1 cm (min-max)	28.3 - 34.3	28.3 - 34.3	28.3 - 34.3
X2 cm	38.7	38.7	38.7



FINITURE / FINISHES / Покрытие

- Ghisa / Cast iron / чугун
- Titanio / Titanium / титан
- Nero / Black / черный

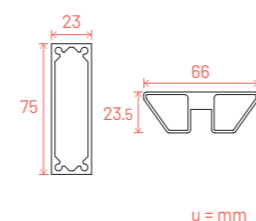

Accessori / Accessories / Аксессуары

	Mensola Shelf полка pagina 198		Mensola Shelf полка pagina 198		Mensola Shelf полка pagina 198
	Pensile Cabinet подвесной ящик pagina 197		Pensile Cabinet подвесной ящик pagina 197		Pensile Cabinet подвесной ящик pagina 197
	Mensola legno 60 Wooden shelf 60 деревянная полка 60 pagina 196		Mensola legno 90 Wooden shelf 90 деревянная полка 90 pagina 196		Mensola legno 120 Wooden shelf 120 деревянная полка 120 pagina 196

Schema composizioni / Configuration / Схема композиции

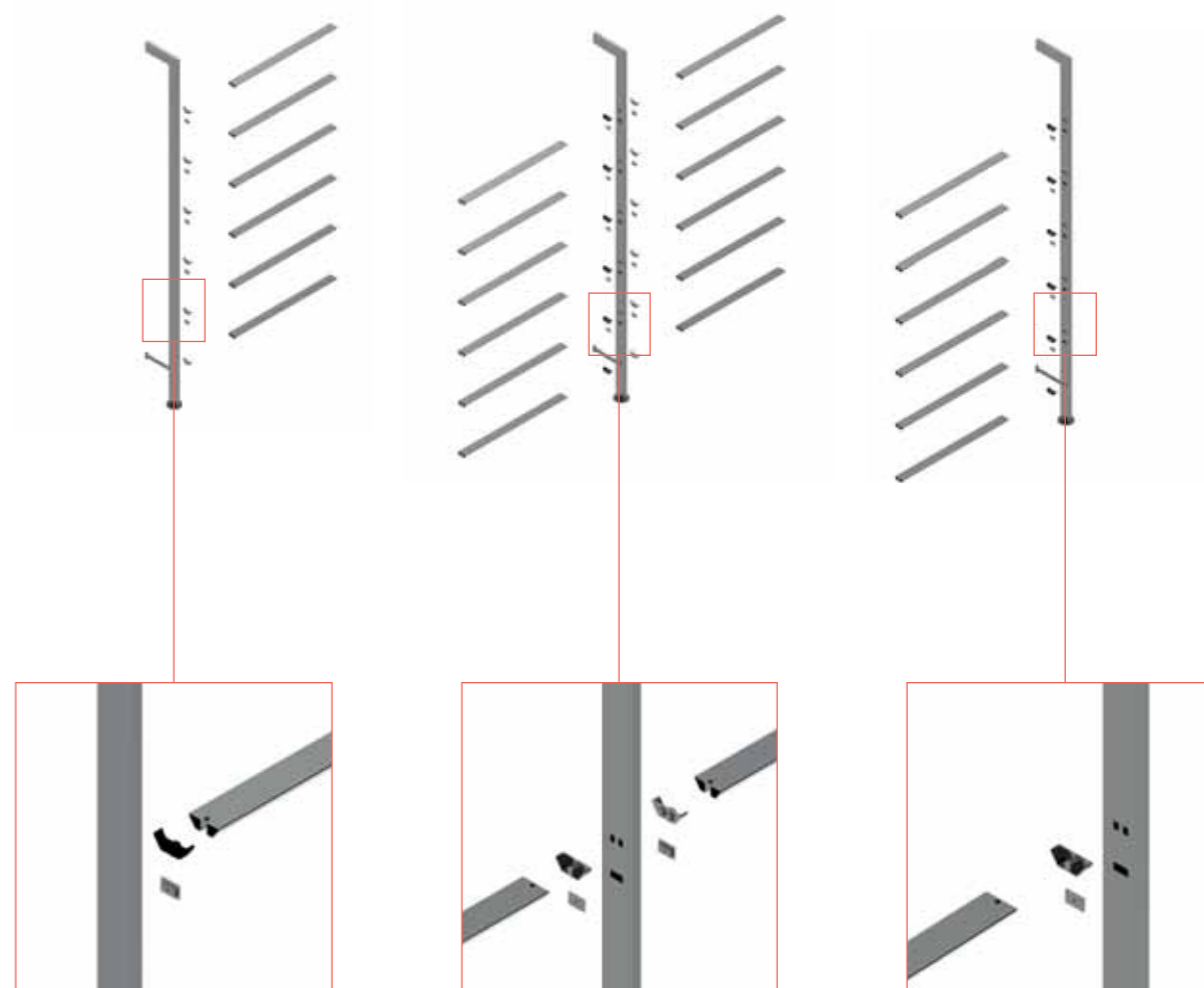



GIOSTRA L LUX

Materiale / Materials / МАТЕРИАЛ
Alluminio / Aluminium / Алюминий



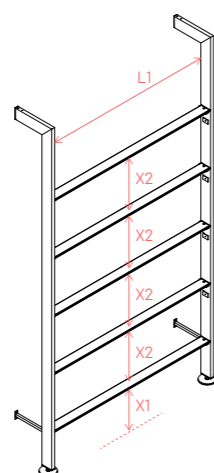

208 x 600 **208 x 900** **208 x 1200**

Kg.	11.2	13.0	14.8
L cm	72.8	102.8	132.8
L1 cm	60.0	90.0	120.0
H cm (min-max)	208.0 - 214.0	208.0 - 214.0	208.0 - 214.0
P cm	29.7	29.7	29.7
X1 cm (min-max)	28.3 - 34.3	28.3 - 34.3	28.3 - 34.3
X2 cm	38.7	38.7	38.7



FINITURE / FINISHES / Покрытие

-  Ghisa / Cast iron / чугуn
-  Titanio / Titanium / титан
-  Nero / Black / черный

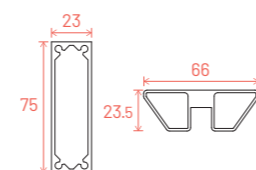

u = mm



230 V



CE

ILLUMINAZIONE

Le nostre illuminazioni integrate da collocare sotto alla traversa orizzontale donano atmosfera, funzionalità e stile. I LED non solo consentono di risparmiare energia, ma grazie a un'illuminazione diffusa, contribuiscono a creare un ambiente rilassato e accogliente.

LIGHTENING

Our integrated lighting to be placed under the horizontal crossbar enhance our furniture features making them extremely stylish and functional. LED lighting is not only the most energy efficient option on the market but, thanks to light diffusion, it also helps to create a relaxing and pleasant ambience.

ОСВЕЩЕНИЕ

Наше встроенное освещение, размещаемое под горизонтальной перекладиной, создает атмосферу, функциональность и стиль. Светодиоды не только экономят энергию, но благодаря рассеянному освещению они помогают создать расслабленную и уютную обстановку.



Profilo
Prolife
алюминиевый профиль

Striscia LED
LED strip
светодиодная лента

Cover in plastica
Plastic cover
пластиковое покрытие

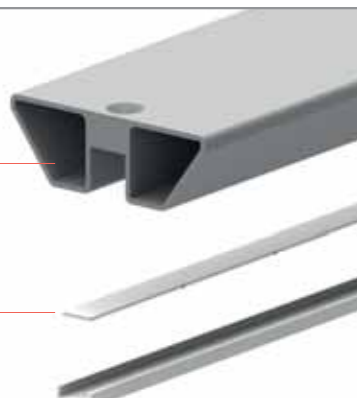

Accessori / Accessories / Аксессуары

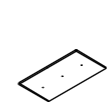

Mensola
Shelf
полка
pagina 198



Mensola
Shelf
полка
pagina 198

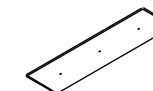

Mensola
Shelf
полка
pagina 198

Schema composizioni / Configuration / Схема композиции

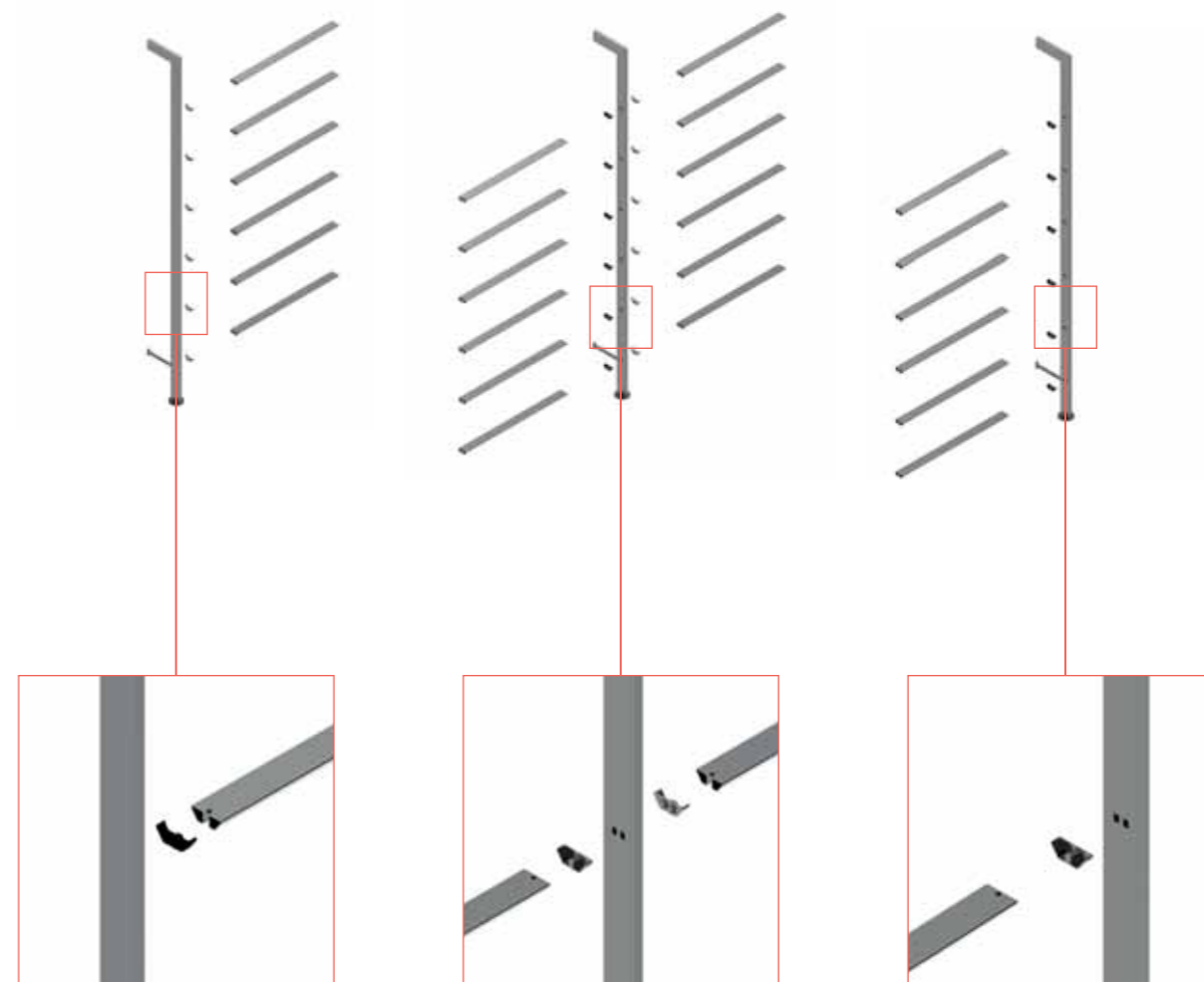

OUTLINE

Semplice e versatile, Outline è la libreria in legno modulare adatta ad arredare gli ambienti della casa. Le cornici in metallo appoggiate a terra alloggiando mensole in legno, regolabili in altezza, che permettono di ospitare in maniera pratica oggetti dalle altezze più varie. Componibile secondo diversi moduli, è il complemento ideale per il soggiorno ma funge anche da comoda libreria per gli altri ambienti della casa.

Simple and adaptable, Outline is the modular wooden bookcase suitable in furnishing any home. The metal frames, resting on the ground, hold wooden shelves, adjustable in height, which allow to put different objects in a practical way. Its composing system makes it the ideal furniture for the living room. It can be convenient bookcase for other rooms too.

Простая и универсальная система Аутлайн - это деревянный модульный книжный шкаф, подходящий для меблировки комнат в доме. Металлические рамы, размещенные на деревянных полках с деревянными полками, регулируются по высоте, что позволяет удобно размещать объекты с самых разных высот. Состоит из различных модулей, это идеальное дополнение для гостиной, но также служит удобным книжным шкафом для других комнат дома.





OUTLINE

Materiale / Materials / МАТЕРИАЛ
Alluminio / Aluminium / Алюминий



LIBOUT/M



LIBOUT/SH

Kg.	6.24	0.03
L cm	7.5	4.0
H cm (min-max)	216.0 - 217.0	3.7
P cm	35.6	3.2
X1 cm	19.0	
X2 cm	32.0	
X3 cm	36.0	
X4 cm	52.0	

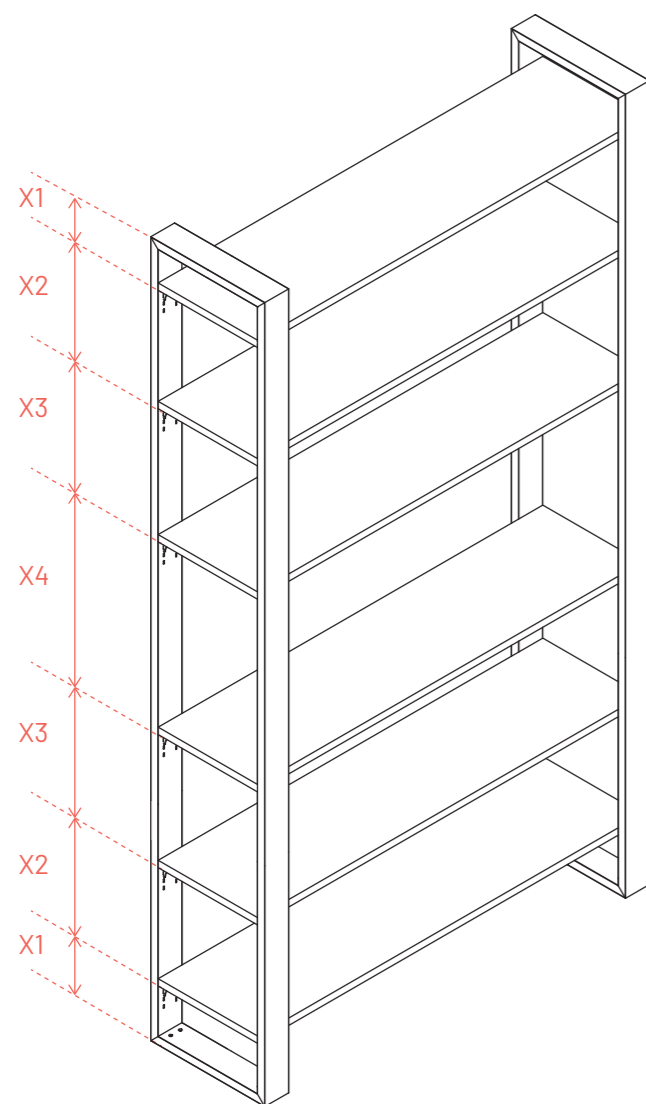

FINITURE / FINISHES / Покрытие

- Titanio / Titanium / титан
- Nero / Black / черный

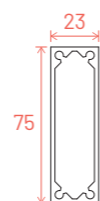

u = mm

Mensola / Shelf / полка

Materiale / Materials / МАТЕРИАЛ
Legno / Wood / Дерево



SW/60X31X4-R	
Kg.	6.6
L cm	60.0
H cm	4.0
P cm	31.0

FINITURE / FINISHES / Покрытие

- Rovere / durmast / дуб

Mensola / Shelf / полка

Materiale / Materials / МАТЕРИАЛ
Legno / Wood / Дерево



SW/90X31X4-R	
Kg.	10.0
L cm	90.0
H cm	4.1
P cm	31.0

FINITURE / FINISHES / Покрытие

- Rovere / durmast / дуб

Mensola / Shelf / полка

Materiale / Materials / МАТЕРИАЛ
Legno / Wood / Дерево



SW/120X31X4-R	
Kg.	13.4
L cm	120.0
H cm	4.0
P cm	31.0

FINITURE / FINISHES / Покрытие

- Rovere / durmast / дуб



PIEDINI DI REGOLAZIONE

Grazie ai piedini di regolazione i montanti possono essere allineati e messi in tensione in modo solido e sicuro in tutta semplicità. Utilizzando i piedini di regolazione è possibile regolare l'altezza fino a 5 cm.

ADJUSTING FEET

Thanks to the adjusting feet, you can easily align the pillars in a solid and safe manner. Using the adjustment feet you can adjust the height up to 5 cm.

РЕГУЛИРУЕМЫЕ НОЖКИ

Благодаря регулируемым ножкам, несущие колонны будут выровнены, прочно и надежно отрегулированы простым способом. Ими можно скорректировать высоту до 5 см.

MODULARE

Una semplicità architettonica che assicura al progetto un'eccezionale versatilità, con la possibilità di realizzare composizioni anche di ampie dimensioni, in assoluta sicurezza. Affiancando più moduli è possibile comporre infinite soluzioni.

MODULAR

An architectural simplicity that assures the project an exceptional versatility, with the opportunity of creating compositions of even greater dimensions, in absolute safety. By joining multiple modules, it is possible to make infinite solutions.

МОДУЛЬНАЯ КОНСТРУКЦИЯ

Архитектурная простота, которая дарит исключительную многогранность системе, и дает возможность создавать даже большие структуры в полной безопасности. Соединяя дополнительные модули системы, можно создать бесконечное количество решений.



DAMA

Essenziale e versatile, dama è una struttura di alluminio con diverse misure a seconda delle esigenze di spazio o di organizzazione degli elementi che deve contenere. Grazie a una vasta gamma di componenti a scelta, è perfetta sia per il bagno che per la cucina, trasformandosi in un attimo da semplice accessorio in vero e proprio complemento di arredo.

Essential and versatile. Dama is a structure made of aluminium in different sizes that you can adapt according to your own space requirements and your favourite objects arrangement. Thanks to a wide range of components available to pick and choose, it is perfect for both the bathroom and the kitchen, turning an ordinary accessory into a real piece of furniture.



Аксессуар дама – существенный и многоцелевой, эта структура из алюминия разных размеров удовлетворит все требования к доступному пространству и уместит все необходимые предметы. Благодаря широкой гамме дополнительных компонентов на ваш выбор, дама подойдет идеально как для ванной, так и для кухни. Она превратится из простого аксессуара в настоящий предмет мебели.







DAMA 360

Materiale / Materials / МАТЕРИАЛ
Alluminio / Aluminium / Алюминий

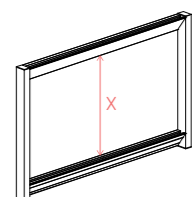
			
	360 x 600	360 x 900	360 x 1200
Kg.	1.4	1.8	2.2
L cm	60.0	90.0	120.0
H cm	36.0	36.0	36.0
P cm	3.0	3.0	3.0
X cm	31.6	31.6	31.6



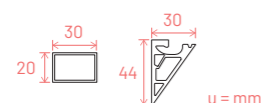

FINITURE / FINISHES / Покрытие

-  Ghisa / Cast iron / чугун
-  Bianco / White / БЕЛЫЙ



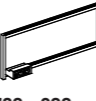

DAMA LUX 360

Materiale / Materials / МАТЕРИАЛ
Alluminio / Aluminium / Алюминий

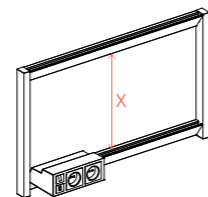
			
	360 x 600	360 x 900	360 x 1200
Kg.	2.1	2.5	2.9
L cm	60.0	90.0	120.0
H cm	36.0	36.0	36.0
P cm	14.0	14.0	14.0
X cm	31.6	31.6	31.6



FINITURE / FINISHES / Покрытие

-  Ghisa / Cast iron / чугун
-  Bianco / White / БЕЛЫЙ

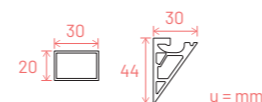

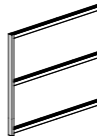
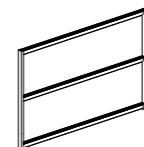

DAMA 720

Materiale / Materials / МАТЕРИАЛ
Alluminio / Aluminium / Алюминий

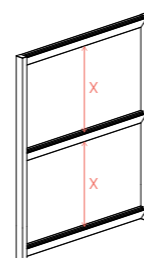
			
	720 x 600	720 x 900	720 x 1200
Kg.	2.3	2.9	3.5
L cm	60.0	90.0	120.0
H cm	72.0	72.0	72.0
P cm	3.0	3.0	3.0
X cm	33.8	33.8	33.8



FINITURE / FINISHES / Покрытие

-  Ghisa / Cast iron / чугун
-  Bianco / White / БЕЛЫЙ

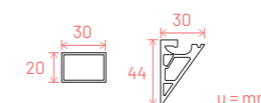

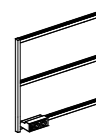
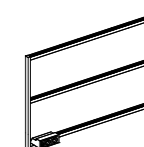

DAMA LUX 720

Materiale / Materials / МАТЕРИАЛ
Alluminio / Aluminium / Алюминий

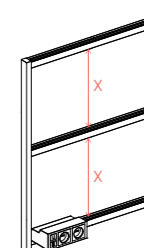
			
	720 x 600	720 x 900	720 x 1200
Kg.	3.0	3.6	4.2
L cm	60.0	90.0	120.0
H cm	72.0	72.0	72.0
P cm	14.0	14.0	14.0
X cm	33.8	33.8	33.8



FINITURE / FINISHES / Покрытие

-  Ghisa / Cast iron / чугун
-  Bianco / White / БЕЛЫЙ

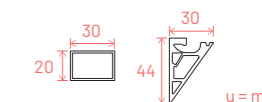

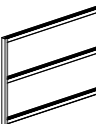
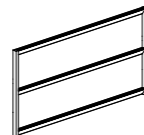

DAMA 600

Materiale / Materials / МАТЕРИАЛ
Alluminio / Aluminium / Алюминий

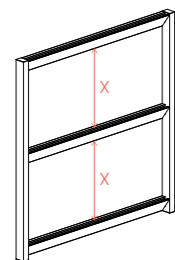
			
	600 x 600	600 x 900	600 x 1200
Kg.	2.0	2.6	3.2
L cm	60.0	90.0	120.0
H cm	60.0	60.0	60.0
P cm	3.0	3.0	3.0
X cm	27.8	27.8	27.8



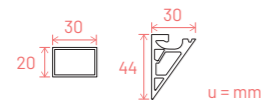

FINITURE / FINISHES / Покрытие

-  Ghisa / Cast iron / чугун
-  Bianco / White / БЕЛЫЙ





DAMA LUX 600

Materiale / Materials / МАТЕРИАЛ
Alluminio / Aluminium / Алюминий

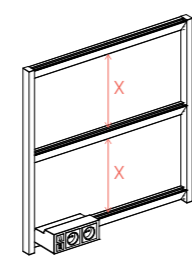
			
	600 x 600	600 x 900	600 x 1200
Kg.	2.7	3.3	3.9
L cm	60.0	90.0	120.0
H cm	60.0	60.0	60.0
P cm	14.0	14.0	14.0
X cm	27.8	27.8	27.8



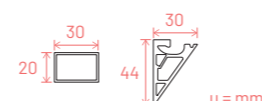

FINITURE / FINISHES / Покрытие

-  Ghisa / Cast iron / чугун
-  Bianco / White / БЕЛЫЙ



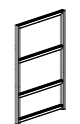

DAMA 960

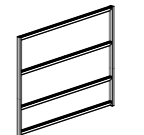
Materiale / Materials / МАТЕРИАЛ
Alluminio / Aluminium / Алюминий

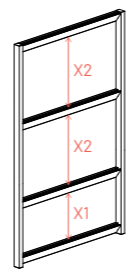
			
	960 x 600	960 x 900	960 x 1200
Kg.	3.3	3.7	4.6
L cm	60.0	90.0	120.0
H cm	96.0	96.0	96.0
P cm	3.0	3.0	3.0
X1 cm	24.0	24.0	24.0
X2 cm	33.8	33.8	33.8



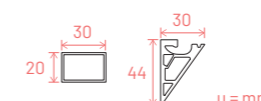

FINITURE / FINISHES / Покрытие

-  Ghisa / Cast iron / чугун
-  Bianco / White / БЕЛЫЙ



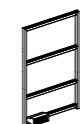

DAMA LUX 960

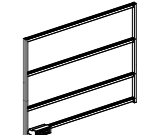
Materiale / Materials / МАТЕРИАЛ
Alluminio / Aluminium / Алюминий

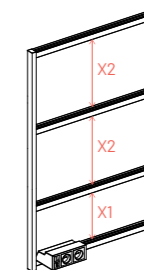
			
	960 x 600	960 x 900	960 x 1200
Kg.	4.0	4.4	5.3
L cm	60.0	90.0	120.0
H cm	96.0	96.0	96.0
P cm	14.0	14.0	14.0
X1 cm	24.0	24.0	24.0
X2 cm	33.8	33.8	33.8



FINITURE / FINISHES / Покрытие

-  Ghisa / Cast iron / чугун
-  Bianco / White / БЕЛЫЙ

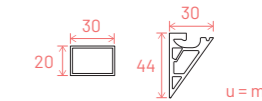



DAMA 540

Materiale / Materials / МАТЕРИАЛ
Alluminio / Aluminium / Алюминий



540 x 600 **540 x 900** **540 x 1200**

Kg.	1.4	1.8	2.2
L cm	60.0	90.0	120.0
H cm	54.0	54.0	54.0
P cm	3.0	3.0	3.0
X1 cm	15.8	15.8	15.8
X2 cm	19.0	19.0	19.0

FINITURE / FINISHES / Покрытие

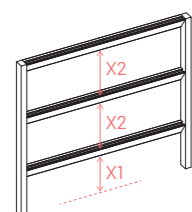

■ Ghisa / Cast iron / чугу́н

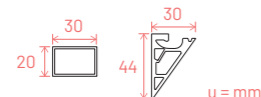

DAMA 560

Materiale / Materials / МАТЕРИАЛ
Alluminio / Aluminium / Алюминий



560 x 600 **560 x 900** **560 x 1200**

Kg.	1.5	1.9	2.3
L cm	60.0	90.0	120.0
H cm	56.0	56.0	56.0
P cm	3.0	3.0	3.0
X1 cm	17.8	17.8	17.8
X2 cm	19.0	19.0	19.0

FINITURE / FINISHES / Покрытие

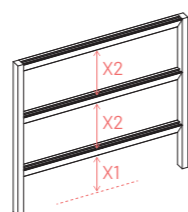

■ Ghisa / Cast iron / чугу́н

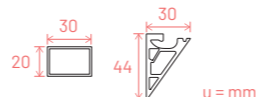

DAMA 570

Materiale / Materials / МАТЕРИАЛ
Alluminio / Aluminium / Алюминий



570 x 600 **570 x 900** **570 x 1200**

Kg.	1.6	2.0	2.4
L cm	60.0	90.0	120.0
H cm	57.0	57.0	57.0
P cm	3.0	3.0	3.0
X1 cm	18.8	18.8	18.8
X2 cm	19.0	19.0	19.0

FINITURE / FINISHES / Покрытие

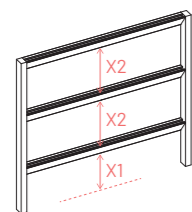

■ Ghisa / Cast iron / чугу́н

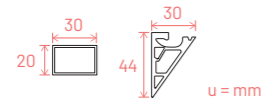

DAMA 580

Materiale / Materials / МАТЕРИАЛ
Alluminio / Aluminium / Алюминий



580 x 600 **580 x 900** **580 x 1200**

Kg.	1.7	2.1	2.5
L cm	60.0	90.0	120.0
H cm	58.0	58.0	58.0
P cm	3.0	3.0	3.0
X1 cm	19.8	19.8	19.8
X2 cm	19.0	19.0	19.0

FINITURE / FINISHES / Покрытие

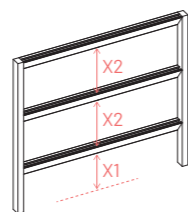

■ Ghisa / Cast iron / чугу́н

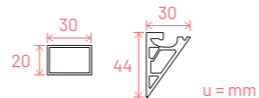

DAMA 1260

Materiale / Materials / МАТЕРИАЛ
Alluminio / Aluminium / Алюминий



1260 x 600 **1260 x 900**

Kg.	2.8	3.6
L cm	60.0	90.0
H cm	126.0	126.0
P cm	3.0	3.0
X1 cm	15.8	15.8
X2 cm	19.0	19.0
X3 cm	24.0	24.0

FINITURE / FINISHES / Покрытие

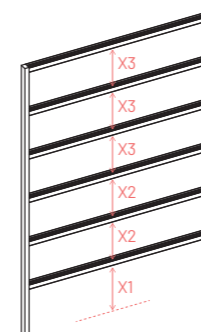

■ Ghisa / Cast iron / чугу́н

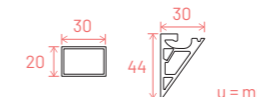

DAMA 1280

Materiale / Materials / МАТЕРИАЛ
Alluminio / Aluminium / Алюминий



1280 x 600 **1280 x 900**

Kg.	2.9	3.7
L cm	60.0	90.0
H cm	128.0	128.0
P cm	3.0	3.0
X1 cm	17.8	17.8
X2 cm	19.0	19.0
X3 cm	24.0	24.0

FINITURE / FINISHES / Покрытие

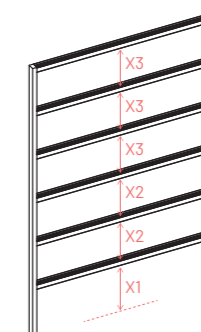

■ Ghisa / Cast iron / чугу́н

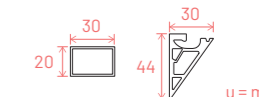

DAMA 1290

Materiale / Materials / МАТЕРИАЛ
Alluminio / Aluminium / Алюминий



1290 x 600 **1290 x 900**

Kg.	3.0	3.8
L cm	60.0	90.0
H cm	129.0	129.0
P cm	3.0	3.0
X1 cm	18.8	18.8
X2 cm	19.0	19.0
X3 cm	24.0	24.0

FINITURE / FINISHES / Покрытие

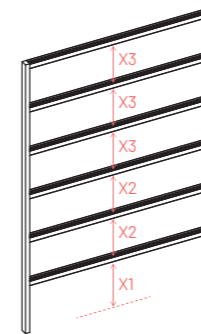

■ Ghisa / Cast iron / чугу́н

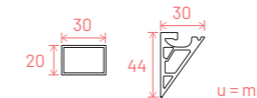

DAMA 1300

Materiale / Materials / МАТЕРИАЛ
Alluminio / Aluminium / Алюминий



1300 x 600 **1300 x 900**

Kg.	3.1	3.9
L cm	60.0	90.0
H cm	130.0	130.0
P cm	3.0	3.0
X1 cm	19.8	19.8
X2 cm	19.0	19.0
X3 cm	24.0	24.0



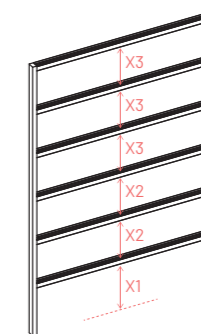

FINITURE / FINISHES / Покрытие

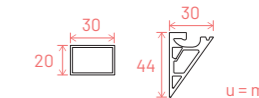

■ Ghisa / Cast iron / чугу́н

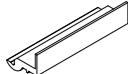
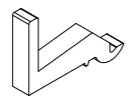
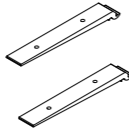
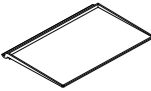

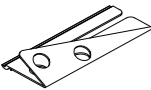
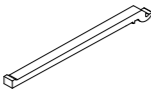
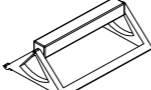
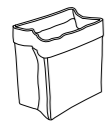
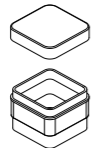
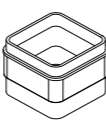
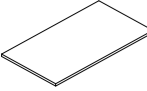
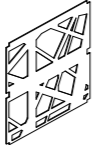
Accessori / Accessories / Аксессуары

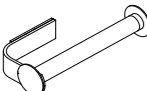
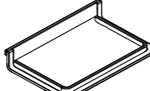
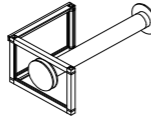
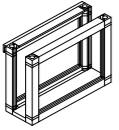
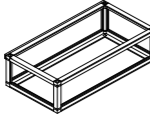
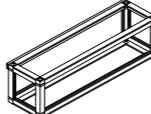
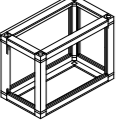
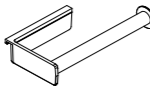
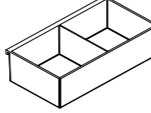
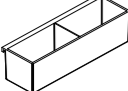
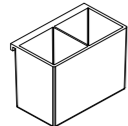
	Adattatore Adapter адаптор pagina 195		Gancio Hook крючок pagina 194		Reggimensola Shelf support полкодержатель pagina 194
	Mensola 270 Shelf 270 полка 270 pagina 192		Mensola 450 Shelf 450 полка 450 pagina 192		Mensola 600 Shelf 600 полка 600 pagina 192
	Portabottiglie Bottle holder держатель для бутылок pagina 195		Portapentole Pots hook держатель для кастрюль pagina 193		Portarotolo Roll holder держатель для бумажного полотенца pagina 193
	Sacchetti contenitori Container bags контейнеры pagina 199		Contenitori Containers контейнеры pagina 188		Contenitori Containers контейнеры pagina 188
	Mensola legno 50 Wooden shelf 50 деревянная полка 50 pagina 196		Pannello ragnatela Web panel панель pagina 198		Contenitori Containers контейнеры pagina 188
	Portarotolo Roll holder держатель для бумажного полотенца pagina 189		Mensola Shelf полка pagina 188		Portarotolo Roll holder держатель для бумажного полотенца pagina 191
	Portatovaglioli Napkins holder держатель для салфеток pagina 191		Portabarattoli Jars holder держатель для баночек pagina 190		Portaspezie Spices holder держатель для специй pagina 190
	Portaposate Cutlery holder держатель для столовых приборов pagina 190		Portarotolo Roll holder держатель для бумажного полотенца pagina 187		Portabarattoli Jars holder держатель для баночек pagina 186
	Portaspezie Spices holder держатель для специй pagina 186		Portaposate Cutlery holder держатель для столовых приборов pagina 186		

○ Abbinare un accessorio ad un adattatore
Match an accessory to an adapter
Использовать один адаптор для крепления контейнера

○ Abbinare due ganci ad un sacchetto contenitore
Match two hooks to a container bag
Использовать два крючка для бумажного мешка – контейнера

○ Abbinare una coppia di staffe reggimensola alla mensola
Match a pair of brackets to the shelf
Использовать пару полкодержателей для одной полки



STEP

Sottile e minimale Step è una struttura in alluminio montata a parete dalle dimensioni compatte ed eleganti. Le mensole che la compongono possono essere sottili piatti di metallo o di legno. Le dimensioni compatte le permettono di essere utilizzata come complemento d'arredo sia in cucina che in soggiorno oppure in bagno come sofisticato porta oggetti.

Step is a thin and minimal wall-mounted metal structure with compact and elegant dimensions. Its shelves can be thin metal or wooden dishes. Its compact size allows any furnishing accessory use in the kitchen or living room but also as a sophisticated objectholder in the bathroom.

Тонкая и минимальная система Ступ - это настенная алюминиевая конструкция с компактными и элегантными размерами. Составляющие полки могут быть тонкими пластинами из металла или дерева. Компактный размер позволяет использовать его как предмет мебели на кухне или в гостиной или в ванной комнате в качестве изысканного держателя для предметов.





STEP

Materiale / Materials / МАТЕРИАЛ
Alluminio / Aluminium / Алюминий

	STEP/360	STEP/600	STEP/720	STEP/1200	STEP/1800	STEP/2040
Kg.	0.60	0.98	1.15	1.90	2.85	3.20
L cm	64.0	64.0	64.0	64.0	64.0	64.0
H cm	36.0	60.0	72.0	120.0	180.0	204.0
P cm	25.0	25.0	25.0	25.0	25.0	25.0
X1 cm	4.3	4.3	4.3	4.3	4.3	4.3

FINITURE / FINISHES / Покрытие

Ghisa / Cast iron / чугун

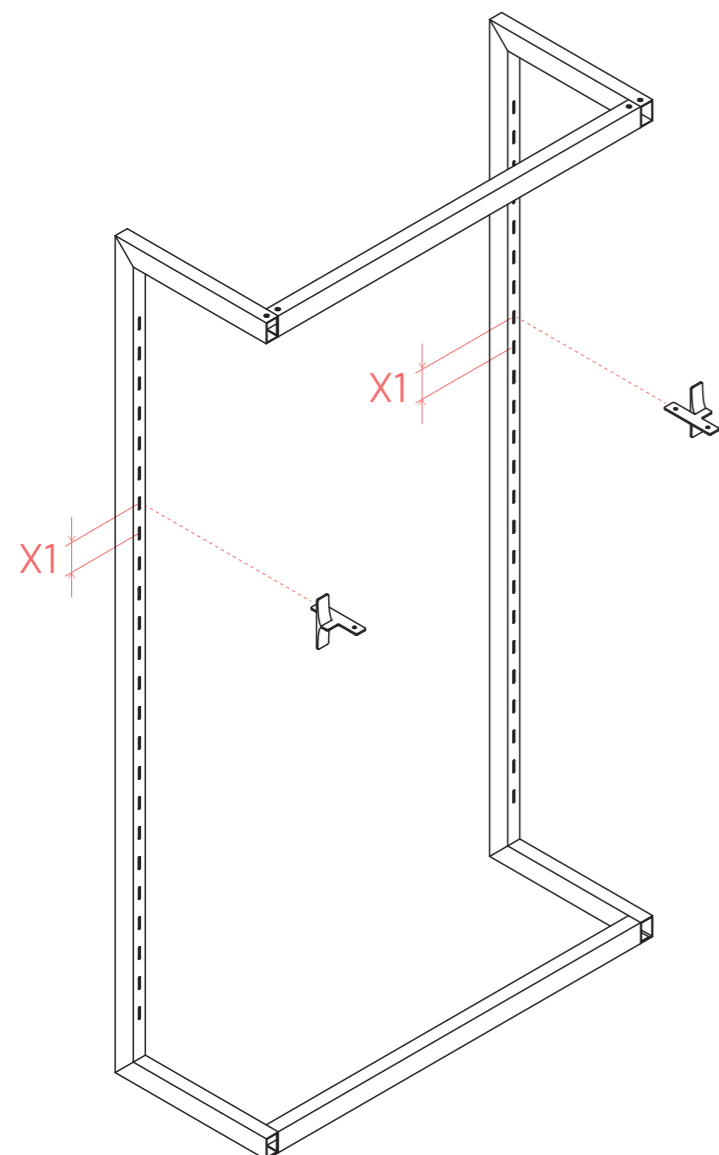

u = mm

Reggimensola / Shelf support / полкодержатель

Materiale / Materials / МАТЕРИАЛ
Zama / Zamak / ЗАМАК



STEP-SH

Kg.	0.1
L cm	3.4
H cm	7.1
P cm	7.6

FINITURE / FINISHES / Покрытие

Ghisa / Cast iron / чугун

Mensola / Shelf / полка

Materiale / Materials / МАТЕРИАЛ
Ferro / Iron / Железо



STEP-600

Kg.	1.7
L cm	60.0
H cm	2.5
P cm	31.0

FINITURE / FINISHES / Покрытие

Ghisa / Cast iron / чугун

Mensola / Shelf / полка

Materiale / Materials / МАТЕРИАЛ
Legno / Wood / Дерево



SW/60x31

Kg.	1.9
L cm	60.0
H cm	1.8
P cm	31.0

FINITURE / FINISHES / Покрытие

Rovere / Wood durmast / дуб
Denim / Denim / джинс
Bianco / White / БЕЛЫЙ

DAMA L

Pratica ed elegante, Dama L è una struttura con profili di alluminio componibili, espandibile a seconda delle esigenze di spazio. Naturale evoluzione di Dama, è dotata di supporti a 90° nella parte superiore per distanziarla dalla parete e di piedini regolabili nella parte inferiore per un preciso e stabile appoggio a pavimento. Grazie a una vasta gamma di componenti, può diventare un meraviglioso orto verticale interno, dotato di luci fitostimolanti che aiutano le piante officinali a crescere in casa.

Practical and elegant. Dama L is a fitted structure made of aluminium profiles and a completely bespoke piece to your specific measurements. It is dama natural evolution. It is equipped with 90-degree supports at the top to distance it from the wall and adjustable feet at the bottom for a precise and stable floor stand. Thanks to a wide range of components you can even use it as a wonderful, upright interior garden, equipped with phyto-stimulating lights to help you grow officinal plants at the home.

Дама эль, практичная и элегантная структура из алюминиевых компонуемых профилей, наращиваемых в зависимости от требований пространства. Это естественная эволюция системы дама, дополнена держателями под углом 90 градусов на верхней части с креплением к стене, и регулируемыми ножками в нижней части для устойчивой фиксации на полу. Благодаря широкой гамме компонентов, может превратиться в прекрасный вертикальный сад, она снабжена фито - стимулирующим светом, который способствует росту растений в закрытом помещении



AWARD 2017
Shortlisted







DAMA L 140

Materiale / Materials / МАТЕРИАЛ
Alluminio / Aluminium / Алюминий



	140 x 60	140 x 90	140 x 120
Kg.	4.2	5.3	7.3
L cm	64.0	94.0	126.0
L1 cm	60.0	90.0	60.0
H cm (min-max)	142.8 - 145.8	142.8 - 145.8	142.8 - 145.8
P cm	15.0	15.0	15.0
X1 cm (min-max)	32.8 - 35.8	32.8 - 35.8	32.8 - 35.8
X2 cm	30.0	30.0	30.0
X3 cm (min-max)	-	-	17.8 - 20.8
X4 cm (min-max)	-	-	32.8 - 35.8

FINITURE / FINISHES / Покрытие

- Ghisa / Cast iron / чугун
- Bianco / White / белый

DAMA L LUX 140

Materiale / Materials / МАТЕРИАЛ
Alluminio / Aluminium / Алюминий



	140 x 60	140 x 90	140 x 120
Kg.	4.2	5.3	7.3
L cm	64.0	94.0	126.0
L1 cm	60.0	90.0	60.0
H cm (min-max)	142.8 - 145.8	142.8 - 145.8	142.8 - 145.8
P cm	15.0	15.0	15.0
X1 cm (min-max)	32.8 - 35.8	32.8 - 35.8	32.8 - 35.8
X2 cm	30.0	30.0	30.0
X3 cm (min-max)	-	-	17.8 - 20.8
X4 cm (min-max)	-	-	32.8 - 35.8

FINITURE / FINISHES / Покрытие

- Ghisa / Cast iron / чугун
- Bianco / White / белый

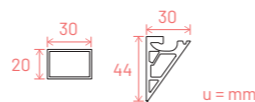
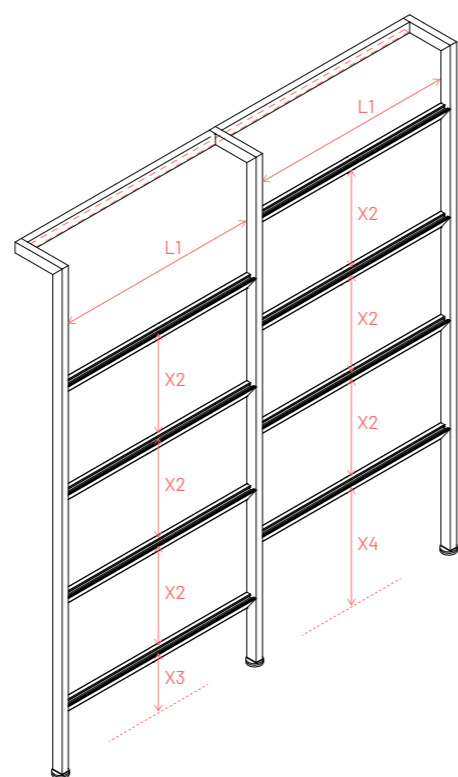
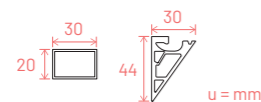
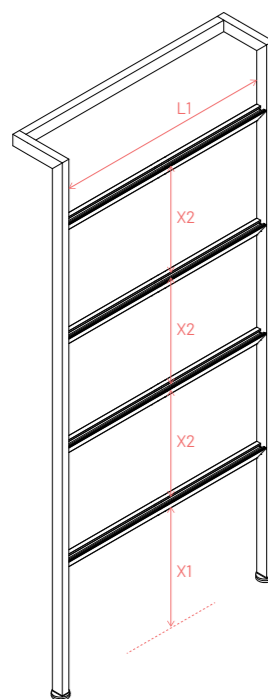

DAMA L 180

Materiale / Materials / МАТЕРИАЛ
Alluminio / Aluminium / Алюминий



	180 x 60	180 x 90	180 x 120
Kg.	5.1	6.5	9.3
L cm	64.0	94.0	126.0
L1 cm	60.0	90.0	60.0
H cm (min-max)	182.8 - 185.8	182.8 - 185.8	182.8 - 185.8
P cm	15.0	15.0	15.0
X1 cm (min-max)	32.8 - 35.8	32.8 - 35.8	32.8 - 35.8
X2 cm	30.0	30.0	30.0
X3 cm (min-max)	-	-	17.8 - 20.8
X4 cm (min-max)	-	-	32.8 - 35.8

FINITURE / FINISHES / Покрытие

- Ghisa / Cast iron / чугун
- Bianco / White / белый

DAMA LUX L 180

Materiale / Materials / МАТЕРИАЛ
Alluminio / Aluminium / Алюминий

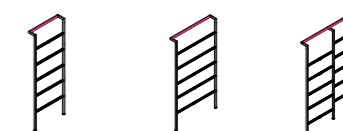



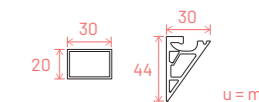
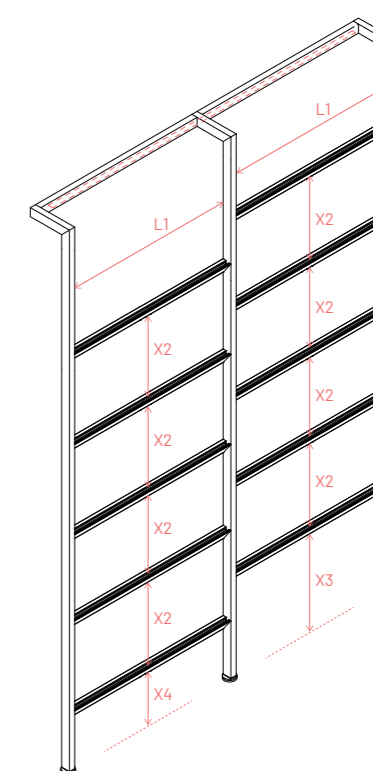
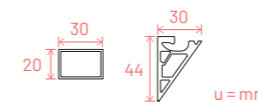
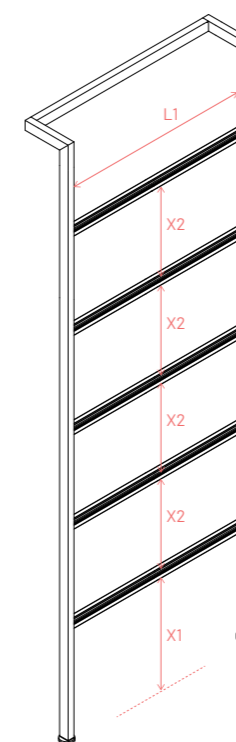

	180 x 60	180 x 90	180 x 120
Kg.	5.1	6.5	9.3
L cm	64.0	94.0	126.0
L1 cm	60.0	90.0	60.0
H cm (min-max)	182.8 - 185.8	182.8 - 185.8	182.8 - 185.8
P cm	15.0	15.0	15.0
X1 cm (min-max)	32.8 - 35.8	32.8 - 35.8	32.8 - 35.8
X2 cm	30.0	30.0	30.0
X3 cm (min-max)	-	-	17.8 - 20.8
X4 cm (min-max)	-	-	32.8 - 35.8

FINITURE / FINISHES / Покрытие

- Ghisa / Cast iron / чугун
- Bianco / White / белый

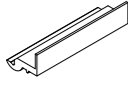
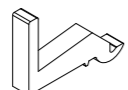
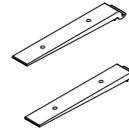

Accessori / Accessories / Аксессуары

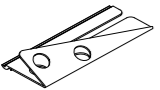
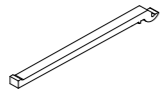
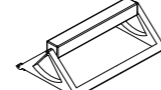
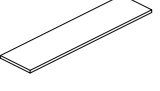
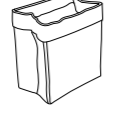
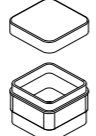
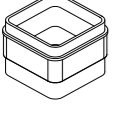
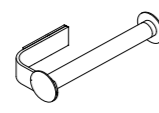
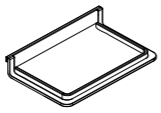
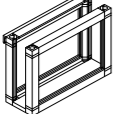
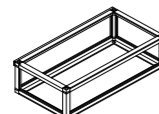
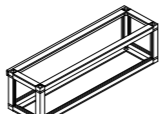
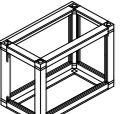
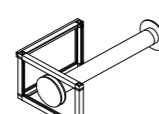
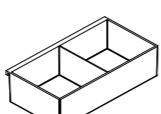
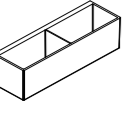
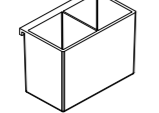
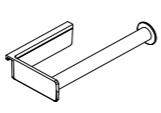
	Adattatore Adapter адаптор pagina 195		Gancio Hook крючок pagina 194		Reggimensola Shelf support полкодержатель pagina 194
	Mensola 270 Shelf 270 полка 270 pagina 192		Mensola 450 Shelf 450 полка 450 pagina 192		Mensola 600 Shelf 600 полка 600 pagina 192
	Portabottiglie Bottle holder держатель для бутылок pagina 195		Portapentole Pots hook держатель для кастрюль pagina 193		Portarotolo Roll holder держатель для бумажного полотенца pagina 193
	Mensola legno 22 Wooden shelf 22 деревянная полка 22 pagina 196		Sacchetti contenitori Container bags контейнеры pagina 199		Contenitori Containers контейнеры pagina 188
	Contenitori Containers контейнеры pagina 188		Portarotolo Roll holder держатель для бумажного полотенца pagina 189		Mensola Shelf полка pagina 188
	Portatovaglioli Napkins holder держатель для салфеток pagina 191		Portabarattoli Jars holder держатель для баночек pagina 190		Portaspezie Spices holder держатель для специй pagina 190
	Portaposate Cutlery holder держатель для столовых приборов pagina 190		Portarotolo Roll holder держатель для бумажного полотенца pagina 191		Portabarattoli Jars holder держатель для баночек pagina 186
	Portaspezie Spices holder держатель для специй pagina 186		Portaposate Cutlery holder держатель для столовых приборов pagina 186		Portarotolo Roll holder держатель для бумажного полотенца pagina 187

○ Abbinare un accessorio ad un adattatore
Match an accessory to an adapter
Использовать один адаптор для крепления контейнера

○ Abbinare due ganci ad un sacchetto contenitore
Match two hooks to a container bag
Использовать два крючка для бумажного мешка – контейнера

○ Abbinare una coppia di staffe reggimensola alla mensola
Match a pair of brackets to the shelf
Использовать пару полкодержателей для одной полки



GRID

Grid è il sottopensile che non si aggancia. La struttura regolabile in altezza gli permette di ottimizzare gli spazi della cucina senza l'utilizzo di viti ma sfruttando lo spazio tra top e pensili. Le barre orizzontali sono arredabili da svariati accessori, mensole, ganci e vaschette dal disegno minimale, rendendolo funzionale ed elegante.

Grid is the kitchen rack that does not hook. The height-adjustable structure allows it to optimize the kitchen spaces without using screws, only taking advantage of the space between countertop and kitchen cupboards. The horizontal bars can be furnished with minimal design accessories, shelves, hooks and tubs, making it functional and elegant.

Грид – это система из алюминиевых рамок, которую не нужно фиксировать на стене. Регулируемая по высоте структура позволяет оптимизировать кухонные помещения без использования винтов, но используя пространство между подвесными и напольными шкафами кухни. Горизонтальные планки могут быть снабжены различными аксессуарами, полками, крючками и контейнерами с минимальным дизайном, что делает систему функциональной и элегантной.

#DAMIANOLATINI

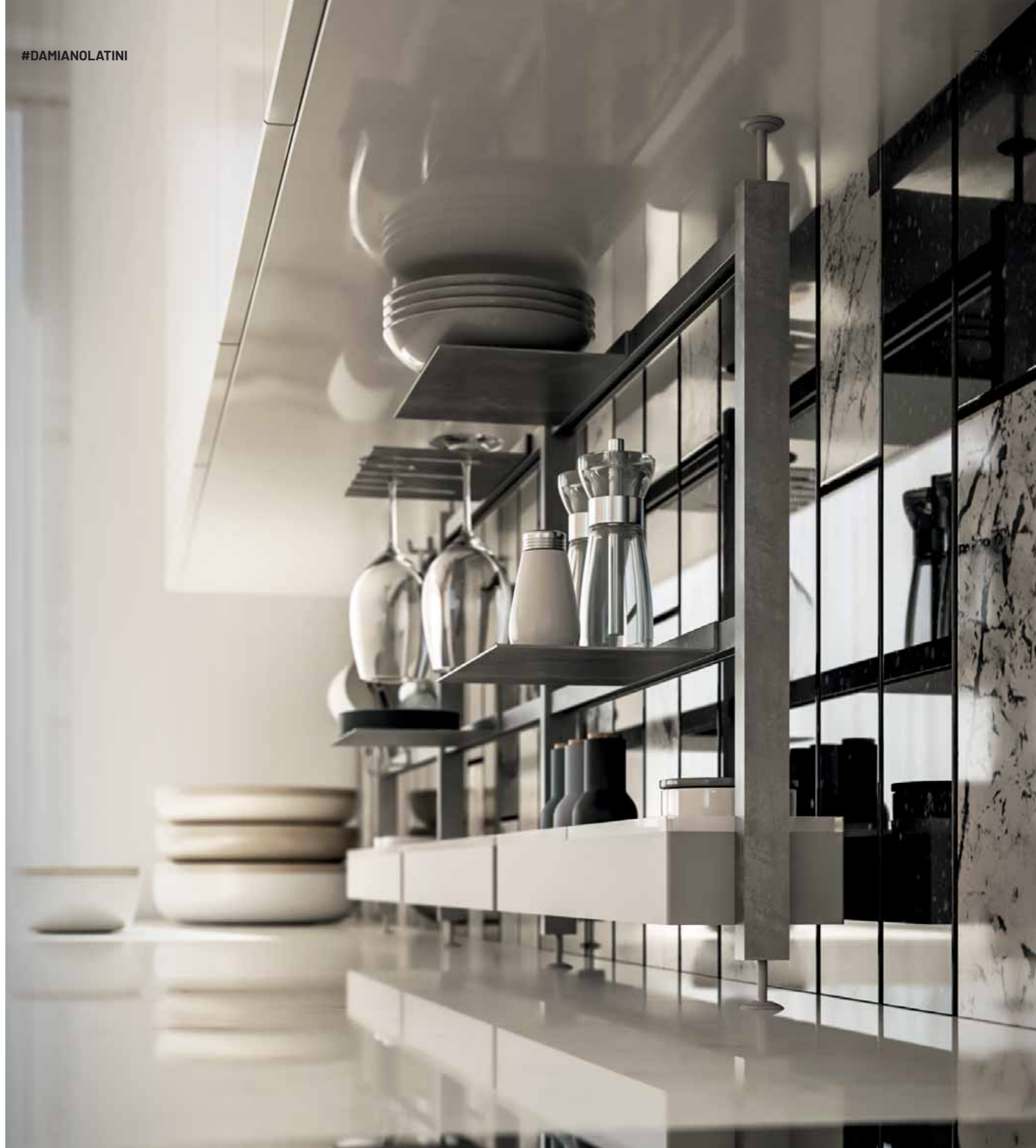



GRID H530 - 600

Materiale / Materials / МАТЕРИАЛ
Alluminio / Aluminium / Алюминий

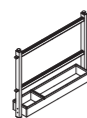

	TIPO A 530 x 600	TIPO B 530 x 600	TIPO C 530 x 600	TIPO D 530 x 600
Kg.	1.15	1.17	1.00	1.02
L cm	60.0	60.0	60.0	60.0
H cm (min-max)	53.0 - 56.0	53.0 - 56.0	53.0 - 56.0	53.0 - 56.0
P cm	12.0	12.0	12.0	12.0
X cm	23.4 - 24.9	23.4 - 24.9	23.4 - 24.9	23.4 - 24.9
X1 cm	17.6	17.6	17.6	17.6

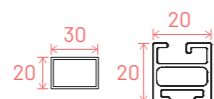
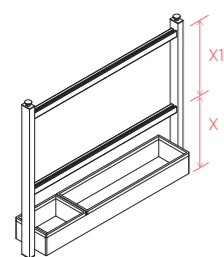

u = mm

FINITURE STRUTTURA / STRUCTURE FINISHES / покрытия структуры

- Anodizzato lucido / Polished anodized / гляцевое анодирование
- Titanio / Titanium / титан
- Nero / Black / черный
- Bianco / White / белый

FINITURE CORNICI / FRAME FINISHES / покрытия структуры

- Nero / Black / черный
- Bianco / White / белый

GRID H530 - 900

Materiale / Materials / МАТЕРИАЛ
Alluminio / Aluminium / Алюминий

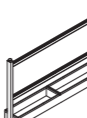
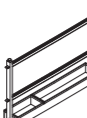
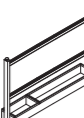

	TIPO A 530 x 900	TIPO B 530 x 900	TIPO C 530 x 900	TIPO D 530 x 900
Kg.	1.35	1.37	1.20	1.22
L cm	90.0	90.0	90.0	90.0
H cm (min-max)	53.0 - 56.0	53.0 - 56.0	53.0 - 56.0	53.0 - 56.0
P cm	12.0	12.0	12.0	12.0
X cm	23.4 - 24.9	23.4 - 24.9	23.4 - 24.9	23.4 - 24.9
X1 cm	17.6	17.6	17.6	17.6

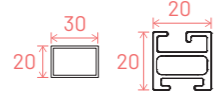
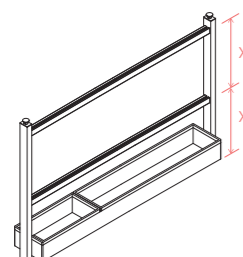

u = mm

FINITURE STRUTTURA / STRUCTURE FINISHES / покрытия структуры

- Anodizzato lucido / Polished anodized / гляцевое анодирование
- Titanio / Titanium / титан
- Nero / Black / черный
- Bianco / White / белый

FINITURE CORNICI / FRAME FINISHES / покрытия структуры

- Nero / Black / черный
- Bianco / White / белый

GRID H560 - 600

Materiale / Materials / МАТЕРИАЛ
Alluminio / Aluminium / Алюминий



	TIPO A 560 x 600	TIPO B 560 x 600	TIPO C 560 x 600	TIPO D 560 x 600
Kg.	1.27	1.29	1.12	1.14
L cm	60.0	60.0	60.0	60.0
H cm (min-max)	56.0 - 59.0	56.0 - 59.0	56.0 - 59.0	56.0 - 59.0
P cm	12.0	12.0	12.0	12.0
X cm	23.4 - 24.9	23.4 - 24.9	23.4 - 24.9	23.4 - 24.9
X1 cm	17.6	17.6	17.6	17.6

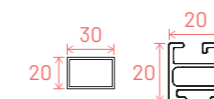
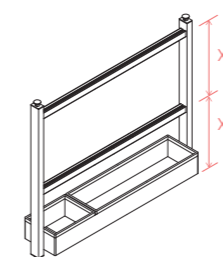

u = mm

FINITURE STRUTTURA / STRUCTURE FINISHES / покрытия структуры

- Anodizzato lucido / Polished anodized / гляцевое анодирование
- Titanio / Titanium / титан
- Nero / Black / черный
- Bianco / White / белый

FINITURE CORNICI / FRAME FINISHES / покрытия структуры

- Nero / Black / черный
- Bianco / White / белый

GRID H560 - 900

Materiale / Materials / МАТЕРИАЛ
Alluminio / Aluminium / Алюминий



	TIPO A 530 x 900	TIPO B 530 x 900	TIPO C 530 x 900	TIPO D 530 x 900
Kg.	1.50	1.52	1.32	1.34
L cm	90.0	90.0	90.0	90.0
H cm (min-max)	56.0 - 59.0	56.0 - 59.0	56.0 - 59.0	56.0 - 59.0
P cm	12.0	12.0	12.0	12.0
X cm	23.4 - 24.9	23.4 - 24.9	23.4 - 24.9	23.4 - 24.9
X1 cm	17.6	17.6	17.6	17.6

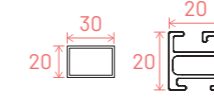
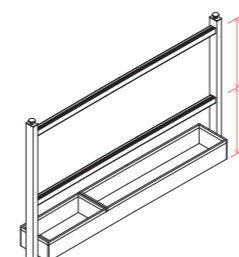

u = mm

FINITURE STRUTTURA / STRUCTURE FINISHES / покрытия структуры

- Anodizzato lucido / Polished anodized / гляцевое анодирование
- Titanio / Titanium / титан
- Nero / Black / черный
- Bianco / White / белый

FINITURE CORNICI / FRAME FINISHES / покрытия структуры

- Nero / Black / черный
- Bianco / White / белый

Tipologia moduli / Unit type / Тип модулей

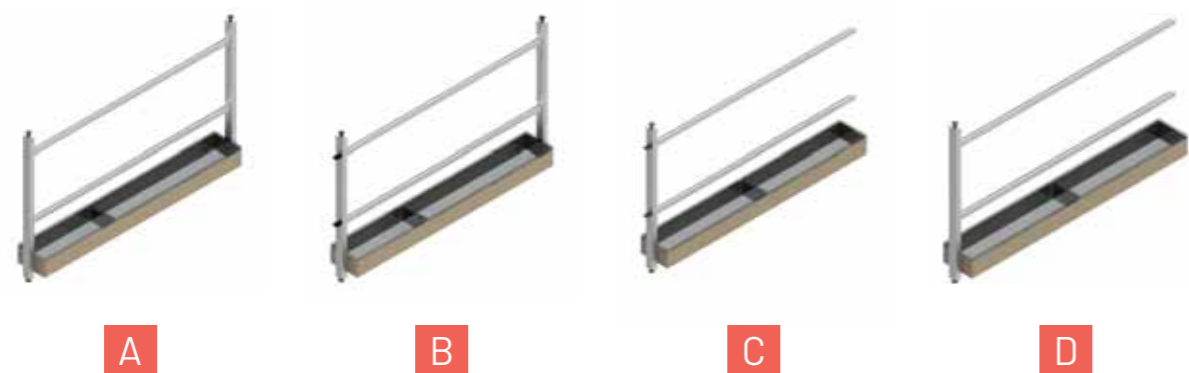

Schema composizioni / Configuration / Схема композиции

A



B + D



B + C + D

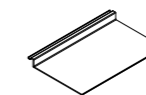

Mensola / Shelf / полка

Materiale / Materials / МАТЕРИАЛ
Alluminio / Aluminum / Алюминий

GRID-SH

Kg.	0.26
L cm	25.0
H cm	2.1
P cm	16.5

Portabicchieri / glass holder
держатель для стеклаMateriale / Materials / МАТЕРИАЛ
Alluminio / Aluminum / Алюминий

GRID-GH

Kg.	0.22
L cm	25.0
H cm	2.1
P cm	16.5

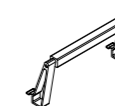
Portarotolo / Roll holder
Полка для бумажногоMateriale / Materials / МАТЕРИАЛ
Alluminio / Aluminum / Алюминий

GRID-RH

Kg.	0.10
L cm	25.0
H cm	12.0
P cm	6.5

Gancio / Hook / крючок

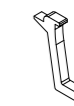
Materiale / Materials / МАТЕРИАЛ
Alluminio / Aluminum / Алюминий

GRID-SETH1

Kg.	0.01
L cm	0.5
H cm	3.9
P cm	3.9



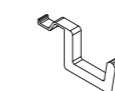

Gancio / Hook / крючок

Materiale / Materials / МАТЕРИАЛ
Alluminio / Aluminum / Алюминий

GRID-SETH2

Kg.	0.03
L cm	0.5
H cm	2.1
P cm	4.6

FINITURE / FINISHES / Покрытие

-  Anodizzato lucido / Polished anodized / глянцевое анодирование
-  Titanio / Titanium / титан
-  Nero / Black / черный
-  Bianco / White / белый

HANG

Un sottopensile sospeso ed estremamente leggero, progettato per ottimizzare lo spazio tra pensile e top, liberando il piano di lavoro da ingombri inutili. Grazie all'innovativo fissaggio al pensile, Hang a differenza delle strutture a parete, consente di evitare lavorazioni e forature allo schienale che possono danneggiare il rivestimento o coprirne il pregio. La struttura modulare costituita da profili verticali e orizzontali si integra perfettamente a qualsiasi cucina, diventando il naturale prolungamento del pensile.

A suspended and extremely light kitchen racks system, designed to optimise space between cabinet and countertop and keep the counter clutter free. Thanks to an innovative cabinet fastening system, Hang doesn't need any wall drilling or work avoiding any risk to damage the kitchen wall cladding. The modular structure made up of studs and crossbeams, can be integrated in any type of kitchen to become a cabinet natural extension. Hang can be equipped with a LED lighting to illuminate the work top and help cooking while minimising energy consumption.

Подвесной, очень легкий, кухонный рейлинг Hang, разработанный, чтобы оптимизировать пространство между нижним и подвесным шкафом, и освободить рабочую поверхность от ненужных предметов. Благодаря инновационному креплению к настенному блоку Hang, в отличие от настенных конструкций, избегает необходимость сверления фартука кухни, что может его повредить или скрыть его ценность. Это модульная структура, состоит из вертикальных и горизонтальных профилей, и идеально вписывается в любую кухню. Она становится естественным продолжением стенового блока. Hang существует в версии со светодиодной подсветкой для освещения рабочей поверхности и облегчения работы в кухне за счет снижения потребления энергии.



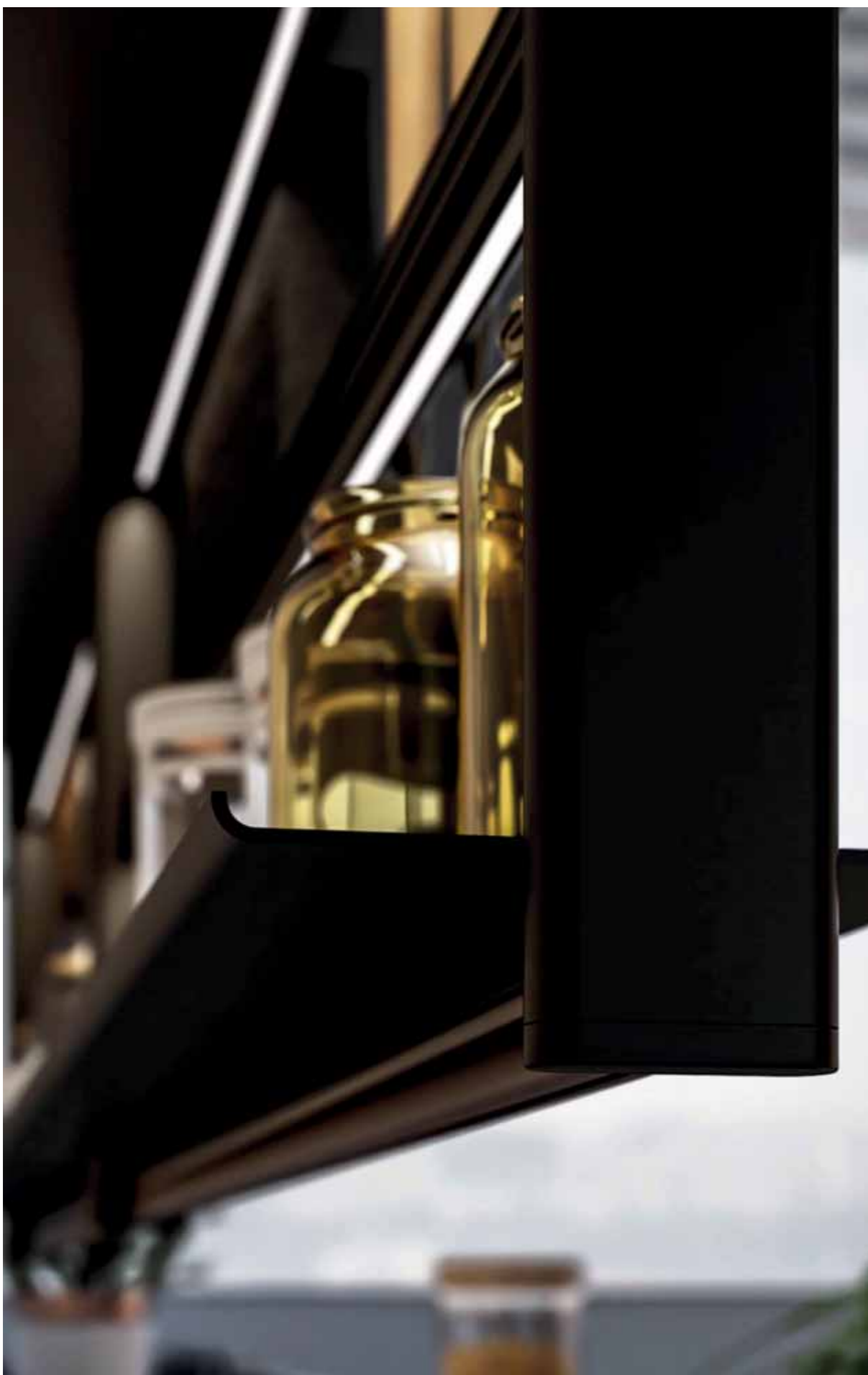

HANG

Materiale / Materials / МАТЕРИАЛ
Alluminio / Aluminum / Алюминий

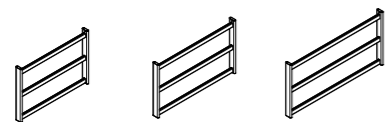

	600	900	1200
Kg.	1.7	2.2	2.7
L cm	60.0	90.0	120.0
H cm	40.4	40.4	40.4
P cm	5.0	5.0	5.0
X cm	13.9	13.9	13.9
X1 cm	15.9	15.9	15.9

FINITURE / FINISHES / Покрытие

- Titanio / Titanium / титан
- Nero / Black / черный

HANG LUX

Materiale / Materials / МАТЕРИАЛ
Alluminio / Aluminum / Алюминий

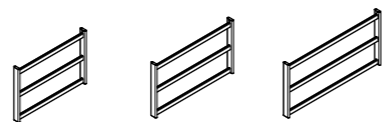

	600	900	1200
Kg.	1.7	2.2	2.7
L cm	60.0	90.0	120.0
H cm	40.4	40.4	40.4
P cm	5.0	5.0	5.0
X cm	13.9	13.9	13.9
X1 cm	15.9	15.9	15.9

FINITURE / FINISHES / Покрытие

- Titanio / Titanium / титан
- Nero / Black / черный



230 V



CE

ILLUMINAZIONE

Le nostre illuminazioni integrate all'interno della struttura donano atmosfera, funzionalità e stile alla tua cucina. Inoltre i LED permettono di risparmiare energia, non solo, con una buona illuminazione, cucini in modo più semplice e sicuro.

LIGHTENING

Our integrated lighting inside the frame enhances our kitchen racks features making them extremely stylish and functional. In addition, LED is the most energy efficient lighting option. Last but not least a better light makes coking easier and safer.

ОСВЕЩЕНИЕ

Наше интегрированное освещение внутри структуры придаст вашей кухне атмосферу, функциональность и стиль. Кроме того, светодиоды экономят энергию. И не только это. При хорошем освещении готовить проще и безопаснее.

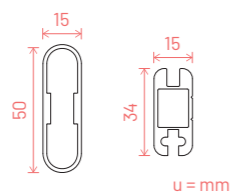
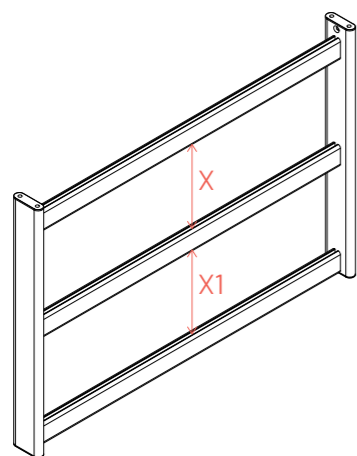

HANG

Materiale / Materials / МАТЕРИАЛ
Alluminio / Aluminum / Алюминий



	600+600	900+900
Kg.	3.2	4.1
L cm	120.0	180.0
H cm	40.4	40.4
P cm	5.0	5.0
X cm	13.9	13.9
X1 cm	15.9	15.9

FINITURE / FINISHES / Покрытие

- Titanio / Titanium / титан
- Nero / Black / черный

HANG LUX

Materiale / Materials / МАТЕРИАЛ
Alluminio / Aluminum / Алюминий

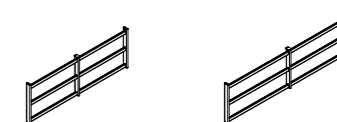

	600+600	900+900
Kg.	3.2	4.1
L cm	120.0	180.0
H cm	40.4	40.4
P cm	5.0	5.0
X cm	13.9	13.9
X1 cm	15.9	15.9

FINITURE / FINISHES / Покрытие

- Titanio / Titanium / титан
- Nero / Black / черный



230 V



CE

ILLUMINAZIONE

Le nostre illuminazioni integrate all'interno della struttura donano atmosfera, funzionalità e stile alla tua cucina. Inoltre i LED permettono di risparmiare energia, non solo, con una buona illuminazione, cucini in modo più semplice e sicuro.

LIGHTENING

Our integrated lighting inside the frame enhances our kitchen racks features making them extremely stylish and functional. In addition, LED is the most energy efficient lighting option. Last but not least a better light makes coking easier and safer.

ОСВЕЩЕНИЕ

Наше интегрированное освещение внутри структуры придаст вашей кухне атмосферу, функциональность и стиль. Кроме того, светодиоды экономят энергию. И не только это. При хорошем освещении готовить проще и безопаснее.

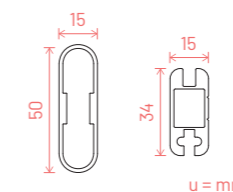
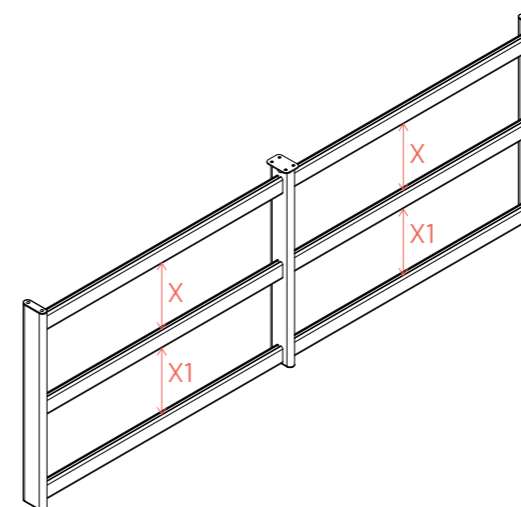

Mensola / Shelf / полка

Materiale / Materials / МАТЕРИАЛ
Alluminio / Aluminum / Алюминий

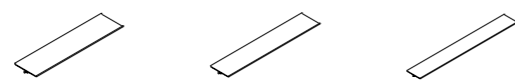

HANG-SH 55		HANG-SH 85		HANG-SH 115	
Kg.	0.6	Kg.	0.9	Kg.	1.3
L cm	55.0	L cm	85.0	L cm	115.0
H cm	2.4	H cm	2.4	H cm	2.4
P cm	14.0	P cm	14.0	P cm	14.0

FINITURE / FINISHES / Покрытие

■ Titanio / Titanium / титан
■ Nero / Black / черный

Portarotolo / Roll holder
Полка для бумажного

Materiale / Materials / МАТЕРИАЛ
Alluminio / Aluminum / Алюминий

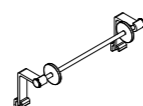

HANG-RH	
Kg.	0.1
L cm	28.5
H cm	8.3
P cm	8.3

FINITURE / FINISHES / Покрытие

■ Titanio / Titanium / титан
■ Nero / Black / черный

Gancio / Hook / крючок

Materiale / Materials / МАТЕРИАЛ
Alluminio / Aluminum / Алюминий

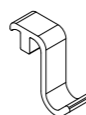

HANG-H	
Kg.	0.1
L cm	1.0
H cm	3.0
P cm	3.0

FINITURE / FINISHES / Покрытие

■ Titanio / Titanium / титан
■ Nero / Black / черный

Tagliere / chopping board / разделочная доска

Materiale / Materials / МАТЕРИАЛ
Alluminio-Legno / Aluminum-Wood / Алюминий-Дерево

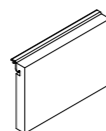

HANG-CBH	
Kg.	1.5
L cm	30.0
H cm	20.4
P cm	4.8

FINITURE / FINISHES / Покрытие

■ Titanio / Titanium / титан
■ Nero / Black / черный

Porta coltelli / knife holder
держатель ножа

Materiale / Materials / МАТЕРИАЛ
Alluminio-Legno / Aluminum-Wood / Алюминий-Дерево

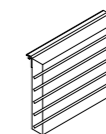

HANG-CBH	
Kg.	1.4
L cm	25.0
H cm	20.4
P cm	5.3

FINITURE / FINISHES / Покрытие

■ Titanio / Titanium / титан
■ Nero / Black / черный



UP

Up è un sottopensile da cucina rivoluzionario che non si fissa allo schienale della cucina né si appoggia al piano di lavoro ma rimane sospeso. Up si fissa alla parte inferiore dei pensili permettendo di ottimizzare gli spazi, senza dover praticare fori su piastrelle e materiali pregiati. La cremagliera modulare con interasse delle barre variabile e la possibilità di personalizzare la struttura con un'ampia serie di accessori da cucina, fanno di Up un sottopensile flessibile ed estremamente funzionale.

Up is a revolutionary kitchen racks system that doesn't need to be fixed to the wall neither placed on the countertop. Up is attached to the lower part of the cabinets and allows you to optimise space without screwing holes on the back of the kitchen. The modular frame is made of bars with flexible interaxle spacing that can be customised with a wide range of kitchen accessories. Up is the result of a great design that combines style and functionality.





UP 600

Materiale / Materials / МАТЕРИАЛ
Alluminio / Aluminum / Алюминий



600

Kg.	1.3
L cm	60.0
H cm	40.0
P cm	8.5
X cm	7.6

FINITURE / FINISHES / Покрытие

- Antracite / Anthracite / антрацит
- Nero / Black / черный

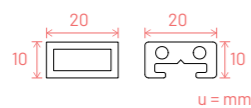
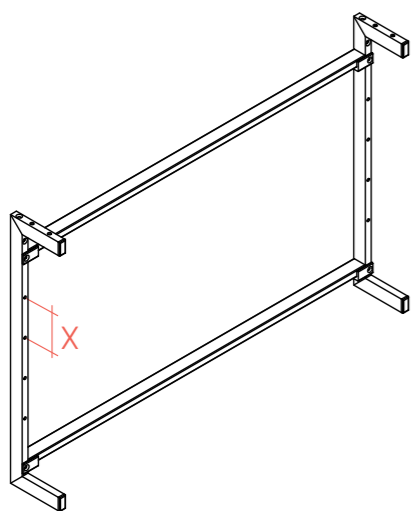

UP 900

Materiale / Materials / МАТЕРИАЛ
Alluminio / Aluminum / Алюминий

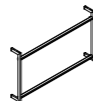

900

Kg.	1.5
L cm	90.0
H cm	40.0
P cm	8.5
X cm	7.6

FINITURE / FINISHES / Покрытие

- Antracite / Anthracite / антрацит
- Nero / Black / черный

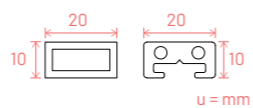
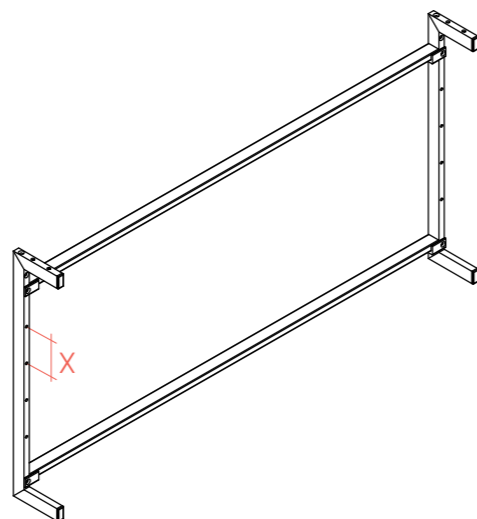

Mensola / Shelf / полка

Materiale / Materials / МАТЕРИАЛ
Alluminio / Aluminum / Алюминий

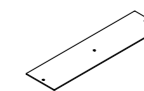

UP-SH 600

Kg.	0.7
L cm	58.0
H cm	0.6
P cm	15.0

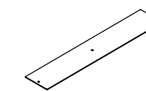

UP-SH 900

Kg.	1.1
L cm	88.0
H cm	0.6
P cm	15.0

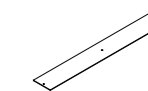

UP-SH 1200

Kg.	1.5
L cm	118.0
H cm	0.6
P cm	15.0

Portarotolo / Roll holder
Полка для бумажного

Materiale / Materials / МАТЕРИАЛ
Alluminio / Aluminum / Алюминий

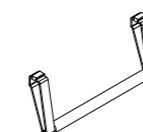

UP-RH

Kg.	1.8
L cm	28.5
H cm	12.0
P cm	5.0

Gancio / Hook / крючок

Materiale / Materials / МАТЕРИАЛ
Alluminio / Aluminum / Алюминий

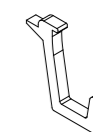

UP-H

Kg.	0.01
L cm	0.5
H cm	3.9
P cm	3.9

Portabicchieri / glass holder
держатель для стекла

Materiale / Materials / МАТЕРИАЛ
Alluminio / Aluminum / Алюминий

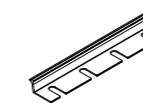

UP-GH

Kg.	0.5
L cm	43.0
H cm	4.0
P cm	8.0

FINITURE / FINISHES / Покрытие

- Antracite / Anthracite / антрацит
- Nero / Black / черный

BACK

Back è una sottile piastra metallica estremamente versatile e componibile. La superficie forata, a cui si possono agganciare svariati accessori, ne permette infinite combinazioni, per rispondere a tutte le caratteristiche che il sottopensile ha in cucina.

Back is a thin, versatile and modular metal plate. The perforated surface, to which you can hook several accessories, allows to create infinite combinations to fit all the needs of the kitchen rack.

Бэк - тонкая, чрезвычайно универсальная и модульная металлическая пластина. Перфорированная поверхность, на которую вы можете зацепить различные аксессуары. Возможны бесконечные сочетания, которые отвечают всем функциям рейлинговой системы на кухне







BACK 240

Materiale / Materials / МАТЕРИАЛ
Ferro / Iron / Железо

	240 x 900	240 x 1200	240 x 1500
Kg.	15.05	12.25	9.52
L cm	90.0	120.0	150.0
H cm	24.0	24.0	24.0
P cm	2.0	2.0	2.0
X1 cm	5.5	5.5	5.5
X2 cm	5.0	5.0	5.0

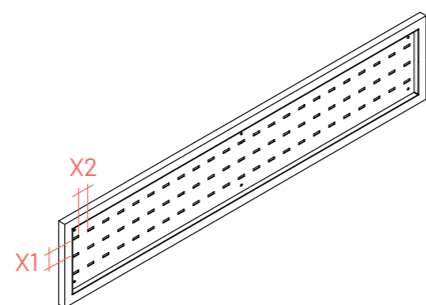

FINITURE / FINISHES / Покрытие

■ Grafite / Graphite / графит

BACK 360

Materiale / Materials / МАТЕРИАЛ
Ferro / Iron / Железо

	360 x 900	360 x 1200	360 x 1500
Kg.	17.64	14.56	11.41
L cm	90.0	120.0	150.0
H cm	36.0	36.0	36.0
P cm	2.0	2.0	2.0
X1 cm	5.5	5.5	5.5
X2 cm	5.0	5.0	5.0

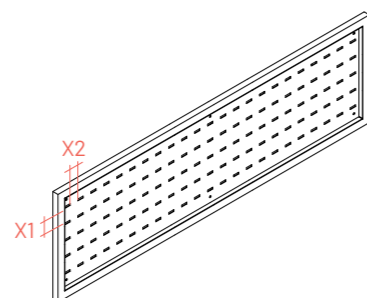

FINITURE / FINISHES / Покрытие

■ Grafite / Graphite / графит

BACK 480

Materiale / Materials / МАТЕРИАЛ
Ferro / Iron / Железо

	480 x 900	480 x 1200	480 x 1500
Kg.	20.44	16.87	13.44
L cm	90.0	120.0	150.0
H cm	48.0	48.0	48.0
P cm	2.0	2.0	2.0
X1 cm	5.5	5.5	5.5
X2 cm	5.0	5.0	5.0

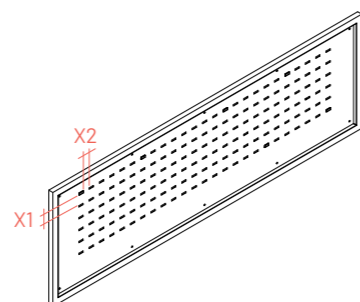

FINITURE / FINISHES / Покрытие

■ Grafite / Graphite / графит

BACK 480 LUX

Materiale / Materials / МАТЕРИАЛ
Ferro / Iron / Железо

	480 x 900	480 x 1200	480 x 1500
Kg.	20.44	16.87	13.44
L cm	90.0	120.0	150.0
H cm	48.0	48.0	48.0
P cm	2.0	2.0	2.0
X1 cm	5.5	5.5	5.5
X2 cm	5.0	5.0	5.0

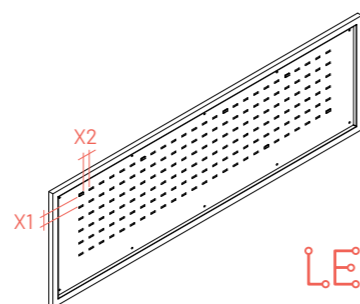

LED
230 V



FINITURE / FINISHES / Покрытие

■ Grafite / Graphite / графит

Mensola / Shelf / полка

Materiale / Materials / МАТЕРИАЛ
Alluminio / Aluminum / Алюминий



BACK-SH

Kg.	0.34
L cm	32.0
H cm	1.5
P cm	12.5

FINITURE / FINISHES / Покрытие

■ Grafite / Graphite / графит

Portaspezie / Spices holder
держатель для специй

Materiale / Materials / МАТЕРИАЛ
Alluminio / Aluminum / Алюминий

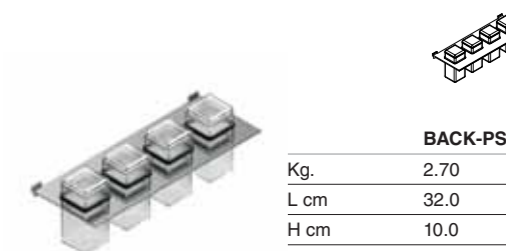

BACK-PS

Kg.	2.70
L cm	32.0
H cm	10.0
P cm	12.5

FINITURE / FINISHES / Покрытие

■ Grafite / Graphite / графит

Portarotolo / Roll holder
Полка для бумажного

Materiale / Materials / МАТЕРИАЛ
Alluminio / Aluminum / Алюминий

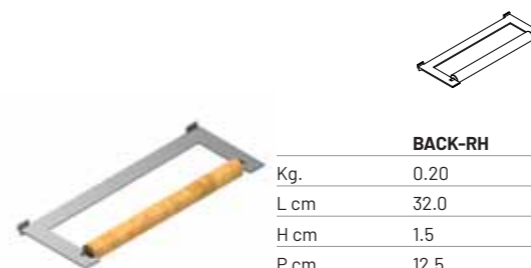

BACK-RH

Kg.	0.20
L cm	32.0
H cm	1.5
P cm	12.5

FINITURE / FINISHES / Покрытие

■ Grafite / Graphite / графит

Gancio / Hook / крючок

Materiale / Materials / МАТЕРИАЛ
Alluminio / Aluminum / Алюминий

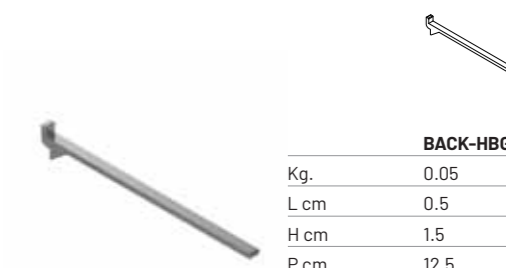

BACK-HBG

Kg.	0.05
L cm	0.5
H cm	1.5
P cm	12.5

FINITURE / FINISHES / Покрытие

■ Grafite / Graphite / графит

Gancio / Hook / крючок

Materiale / Materials / МАТЕРИАЛ
Alluminio / Aluminum / Алюминий



BACK-HSN

Kg.	0.02
L cm	0.5
H cm	1.5
P cm	2.8

FINITURE / FINISHES / Покрытие

■ Grafite / Graphite / графит

Porta tablet / Tablet holder
держатель для планшета

Materiale / Materials / МАТЕРИАЛ
Alluminio / Aluminum / Алюминий

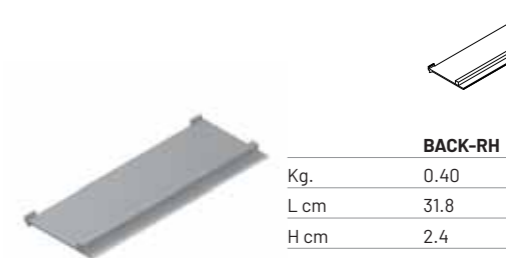

BACK-RH

Kg.	0.40
L cm	31.8
H cm	2.4
P cm	12.5

FINITURE / FINISHES / Покрытие

■ Grafite / Graphite / графит

PIPE

Emblema dello stile industrial, Pipe è una libreria/dispensa modulare, disponibile in varie lunghezze ed accessoriata con mensole in rovere. La caratteristica che contraddistingue questo complemento d'arredo è la struttura costituita da tubi idraulici in alluminio verniciabile. Pipe è collocabile sia in soggiorno come libreria sia in cucina, per essere utilizzata come dispensa aperta o in un open space per svolgere entrambe le funzioni. Pipe non solo è multifunzionale e comodo da avere in casa, ma grazie al design originale e minimal dà anche un tocco contemporaneo alla vostra casa.

Industrial style emblem, Pipe is a modular bookcase/pantry available in different sizes and equipped with wooden shelves. Its main feature is the structure made of aluminium hydraulic pipes. Pipe can be placed either in the living room as a bookcase or in the kitchen as an open pantry or in an open space to be used for both purposes. Pipe isn't only multifunctional and convenient but thanks to its minimal design it gives a modern touch to your house.

Эмблема промышленного стиля, Pipe- модульный книжный шкаф / кладовая, доступна различной длины и оснащена дубовыми полками. Характеристика, которая отличает этот элемент мебели - это структура, состоящая из гидравлических труб из окрашиваемого алюминия. Pipe размещается как в гостиной, в виде книжного шкафа, так и на кухне, в качестве открытой кладовой, или в открытом пространстве для выполнения обеих функций. Pipe не только многофункциональна и удобна для дома, но благодаря оригинальному и минимальному дизайну он также дает нотку современного стиля для вашего дома.





PIPE

Materiale / Materials / МАТЕРИАЛ
Alluminio / Aluminium / Алюминий

	PIPE 360	PIPE 600	PIPE 720	PIPE 1200	PIPE 1800
Kg.	0.97	1.22	1.35	1.85	2.52
L cm	6.0	6.0	6.0	6.0	6.0
H cm	36.0	60.0	72.0	120.0	180.0
P cm	23.0	23.0	23.0	23.0	23.0
X1 cm	3.6	3.6	3.6	3.6	3.6

FINITURE / FINISHES / Покрытие

 Grafite / Graphite / графит

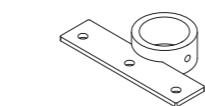
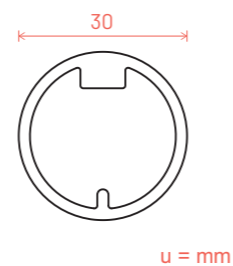
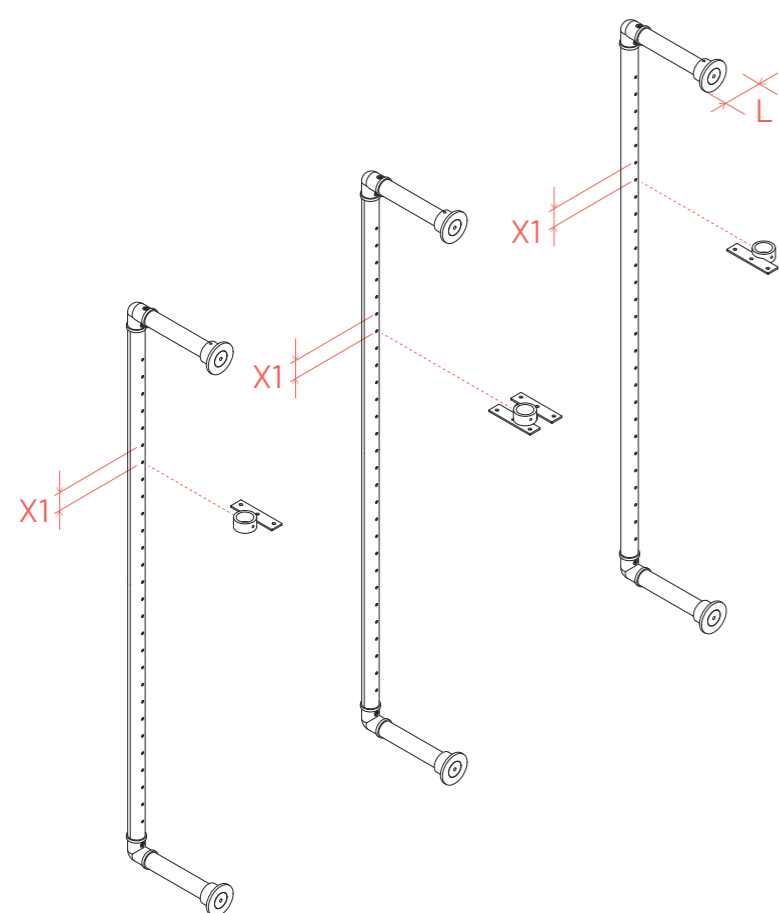

PIPE/SH

Kg.	0.5
L cm	10.0
H cm	2.0
P cm	6.0

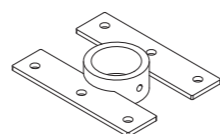

PIPE/SHC

Kg.	0.7
L cm	10.0
H cm	2.0
P cm	8.0

Accessori / Accessories / Аксессуары

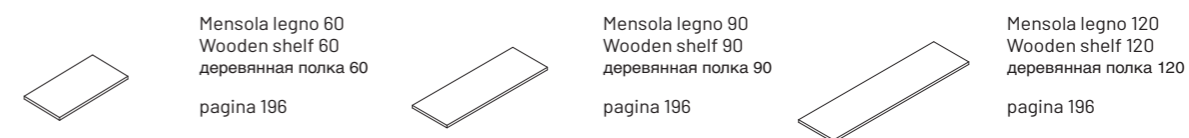

Mensola legno 60
Wooden shelf 60
деревянная полка 60
pagina 196

Mensola legno 90
Wooden shelf 90
деревянная полка 90
pagina 196

Mensola legno 120
Wooden shelf 120
деревянная полка 120
pagina 196

Schema composizioni / Configuration / Схема композиции

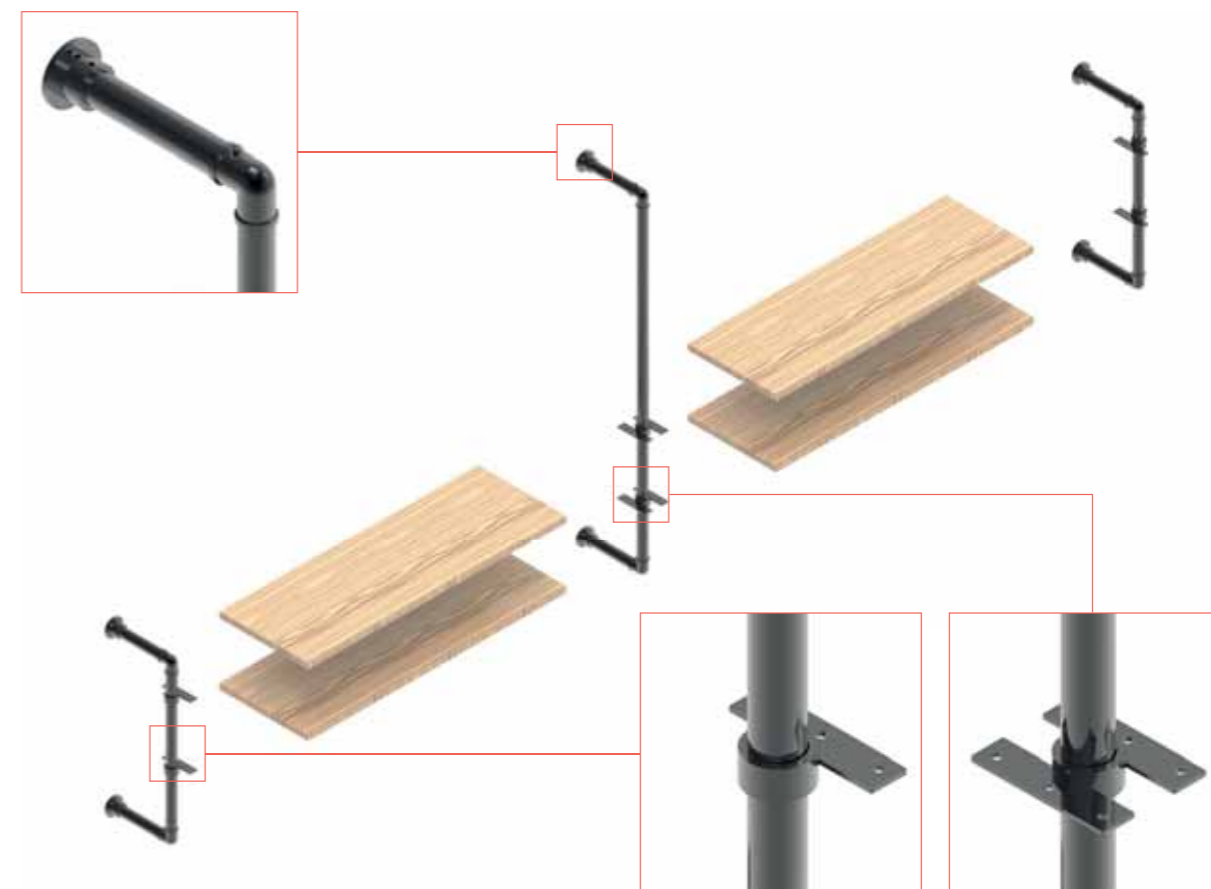

SHELL

Dinamico e contemporaneo Shell reinterpretava il concetto di complemento di arredo. Grazie alla sua struttura in metallo ripetibile e le mensole ad incastro in legno arreda gli ambienti a 360 gradi. Le cornici in metallo, fissate alle pareti sostengono le mensole in legno secondo altezze personalizzabili. La struttura componibile permette di creare soluzioni infinite, adattabili a tutti gli angoli della casa.

Dynamic and contemporary, Shell reshapes the concept of furnishing accessories. Thanks to its repeatable metal structure and the interlocking wooden shelves, it furnishes all-round environments. The metal frames, fixed to the walls, support the wooden shelves according to customizable heights. The modular structure allows you to create infinite solutions, adaptable to all corners of the house.

Динамичная и современная система Шел переосмысливает концепцию аксессуаров для мебели. Благодаря своей повторяемой металлической структуре и деревянным полкам она обустроивает пространство на 360 градусов. Металлические рамы, закрепленные на стенах, поддерживают деревянные полки в соответствии с выбранной высотой. Модульная структура позволяет создавать бесконечные решения, адаптируемые ко всем углам дома.







SHELL 600

Materiale / Materials / МАТЕРИАЛ
Ferro / Iron / Железо



SHELL 600

Kg.	5.92
L cm	8.0
H cm (min - max)	60.0 - 65.0
P cm	25.4
X cm	34.0
X1 cm	5.0

FINITURE / FINISHES / Покрытие

■ Nero / Black / черный

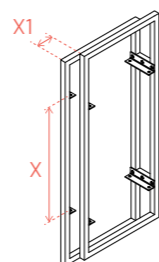
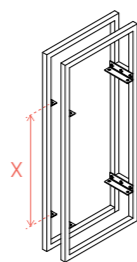

Accessori / Accessories / Аксессуары

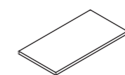

Mensola legno 60
Wooden shelf 60
деревянная полка 60
pagina 196



Mensola legno 90
Wooden shelf 90
деревянная полка 90
pagina 196



Mensola legno 120
Wooden shelf 120
деревянная полка 120
pagina 196

SHELL 1280

Materiale / Materials / МАТЕРИАЛ
Ferro / Iron / Железо



SHELL 1280

Kg.	10.76
L cm	8.0
H cm (min - max)	128.0 - 132.0
P cm	25.4
X cm	34.0
X1 cm	5.0

FINITURE / FINISHES / Покрытие

■ Nero / Black / черный

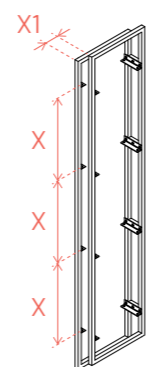
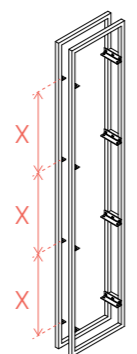

Schema composizioni / Configuration / Схема композиции

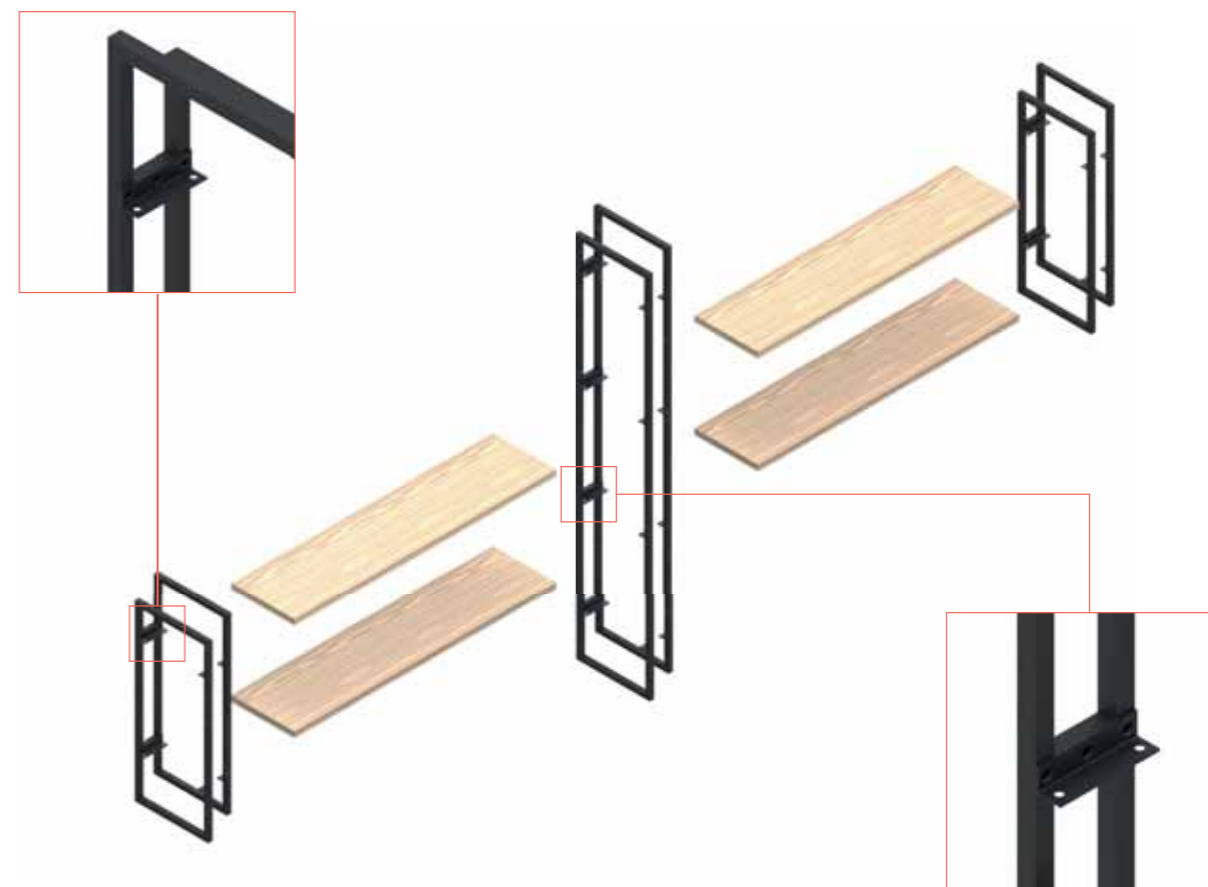

SHELL 1960

Materiale / Materials / МАТЕРИАЛ
Ferro / Iron / Железо



SHELL 1960

Kg.	15.76
L cm	8.0
H cm (min - max)	196.0 - 201.0
P cm	25.4
X cm	34.0
X1 cm	5.0

FINITURE / FINISHES / Покрытие

■ Nero / Black / черный

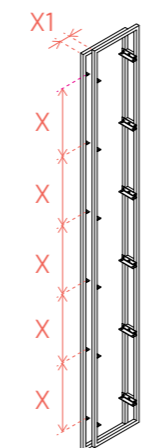
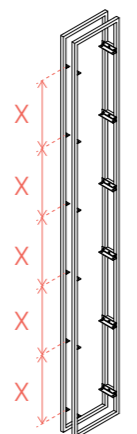

TOWER

Tower è il complemento d'arredo dalle forme e dal disegno sofisticati. Le mensole in metallo si piegano ad intrecciare i lineari piani in legno, creando un complemento d'arredo dal design dinamico. La struttura montata a parete, grazie alle altezze variabili, arreda e risponde alle esigenze di tutti gli ambienti della casa.

Tower is the sophisticated design furnishing accessory. The metal shelves fold to interweave the simple design of the wooden tops, creating a dynamic look. Thanks to the variable heights, the wall-mounted structure furnishes and responds to the all the needs of any living room.

Тауэр - это предмет мебели со сложными формами и дизайном. Металлические полки складываются, чтобы переплестать деревянные линейные поверхности, создавая предмет мебели с динамичным дизайном. Настенная конструкция, благодаря переменной высоте, обеспечивает и отвечает потребностям всех комнат дома.





TOWER-S "A"

Materiale / Materials / МАТЕРИАЛ
Ferro / Iron / Железо

TOWERS S 650	
Kg.	2.11
L cm	10.0
H cm	65.0
P cm	1.2
X1 cm	14.5
X2 cm	36.0

FINITURE / FINISHES / Покрытие

 Ghisa / Cast iron / чугун

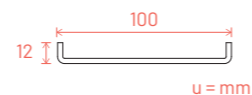

TOWER-S "B"

Materiale / Materials / МАТЕРИАЛ
Ferro / Iron / Железо

TOWERS S 1010	
Kg.	2.96
L cm	10.0
H cm	101.0
P cm	1.2
X1 cm	14.5
X2 cm	36.0

FINITURE / FINISHES / Покрытие

 Ghisa / Cast iron / чугун

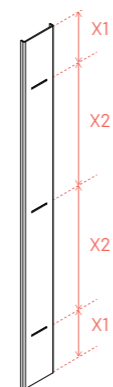

TOWER-S "C"

Materiale / Materials / МАТЕРИАЛ
Ferro / Iron / Железо

TOWERS S 1370	
Kg.	4.20
L cm	10.0
H cm	137.0
P cm	1.2
X1 cm	14.5
X2 cm	36.0

FINITURE / FINISHES / Покрытие

 Ghisa / Cast iron / чугун

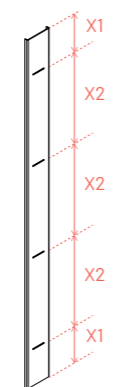

TOWER-S "D"

Materiale / Materials / МАТЕРИАЛ
Ferro / Iron / Железо

TOWERS S 1730	
Kg.	6.24
L cm	10.0
H cm	173.0
P cm	1.2
X1 cm	14.5
X2 cm	36.0

FINITURE / FINISHES / Покрытие

 Ghisa / Cast iron / чугун

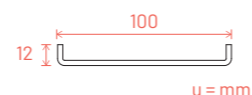
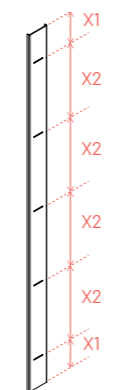

Accessori / Accessories / Аксессуары

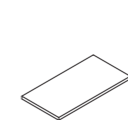

Mensola legno 60
Wooden shelf 60
деревянная полка 60
pagina 196

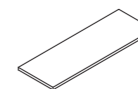

Mensola legno 90
Wooden shelf 90
деревянная полка 90
pagina 196



Mensola legno 120
Wooden shelf 120
деревянная полка 120
pagina 196

Reggimensola / Shelf support
полкодержатель

Materiale / Materials / МАТЕРИАЛ
Ferro / Iron / Железо

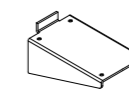

TOWERS-SH

Kg.	0.58
L cm	10.8
H cm	7.4
P cm	14.6

Schema composizioni / Configuration / Схема композиции

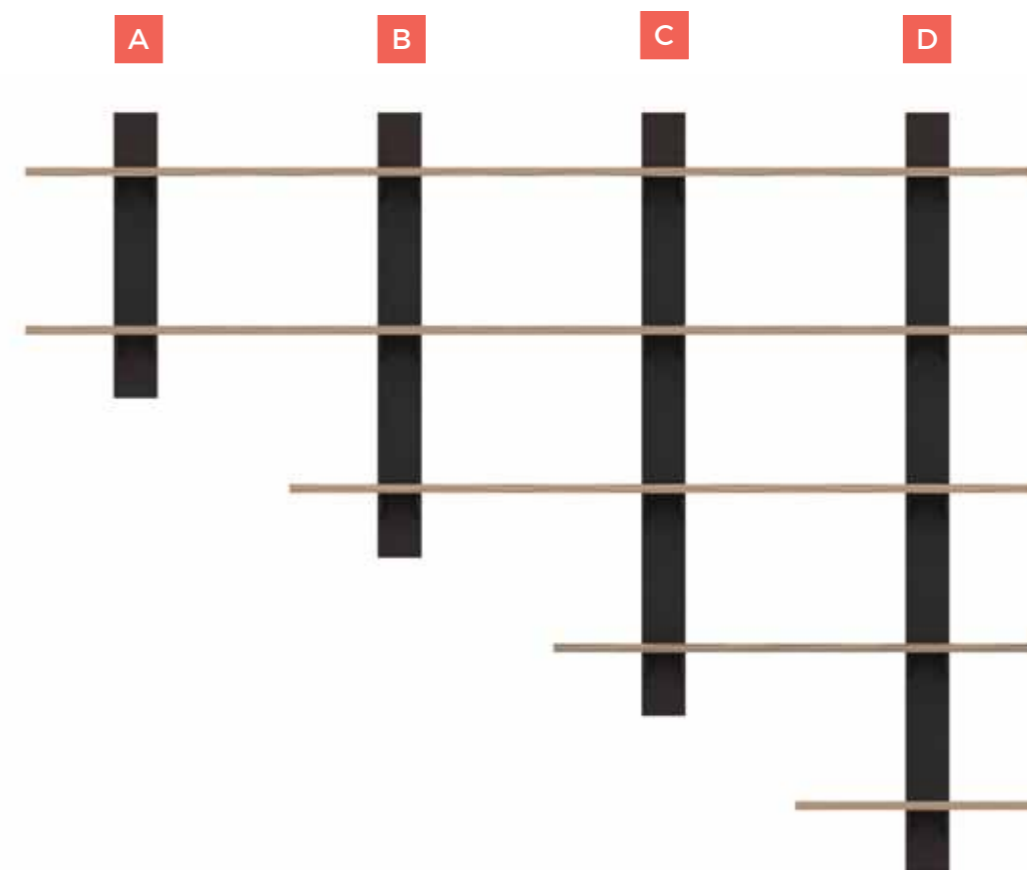

TOWER C 1300

Materiale / Materials / МАТЕРИАЛ
Ferro / Iron / Железо

TOWER C 1300	
Kg.	4.32
L cm	12.0
H cm	130.0
P cm	1.2
X1 cm	6.9
X2 cm	11.6
X3 cm	24.8

FINITURE / FINISHES / Покрытие

■ Titanio / Titanium / титан

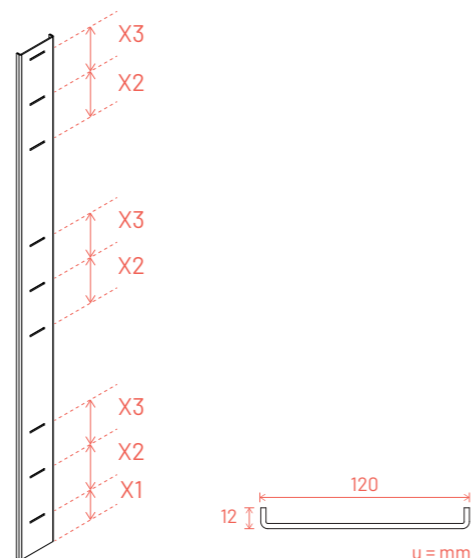

TOWER C 1780

Materiale / Materials / МАТЕРИАЛ
Ferro / Iron / Железо

TOWER C 1780	
Kg.	6.00
L cm	12.0
H cm	178.0
P cm	1.2
X1 cm	6.9
X2 cm	11.6
X3 cm	24.8

FINITURE / FINISHES / Покрытие

■ Titanio / Titanium / титан

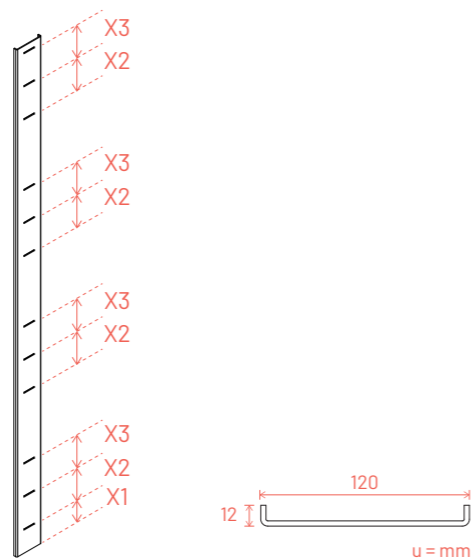
Reggimensola / Shelf support
полкодержатель

Materiale / Materials / МАТЕРИАЛ
Ferro / Iron / Железо

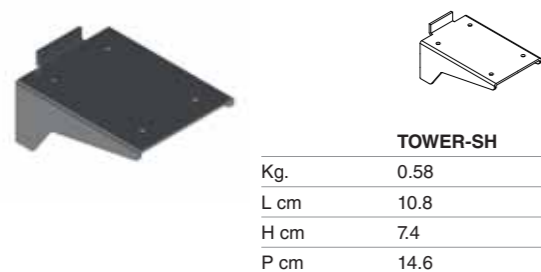

TOWER-SH	
Kg.	0.58
L cm	10.8
H cm	7.4
P cm	14.6

Mensola / Shelf / полка

Materiale / Materials / МАТЕРИАЛ
Legno / Wood / Дерево

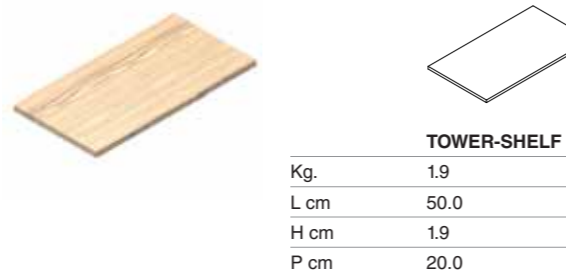

TOWER-SHELF	
Kg.	1.9
L cm	50.0
H cm	1.9
P cm	20.0

Lamiera ML-1 / Shelf support
стальная пластина

Materiale / Materials / МАТЕРИАЛ
Ferro / Iron / Железо

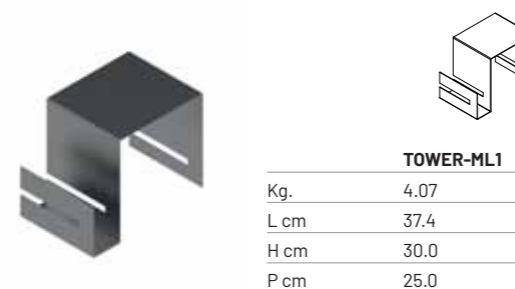

TOWER-ML1	
Kg.	4.07
L cm	37.4
H cm	30.0
P cm	25.0

FINITURE / FINISHES / Покрытие

■ Titanio / Titanium / титан

Lamiera ML-2 / Shelf support
стальная пластина

Materiale / Materials / МАТЕРИАЛ
Ferro / Iron / Железо

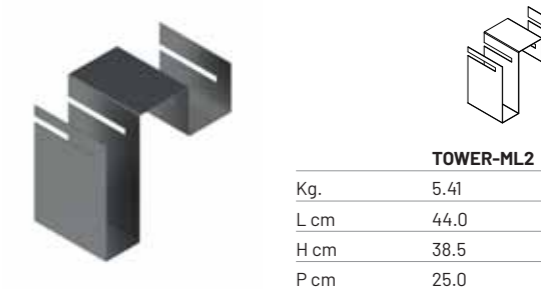

TOWER-ML2	
Kg.	5.41
L cm	44.0
H cm	38.5
P cm	25.0

FINITURE / FINISHES / Покрытие

■ Titanio / Titanium / титан

Schema composizioni / Configuration / Схема композиции



CAOS

Caos è un moderno portabottiglie da parete che svolge anche una funzione decorativa. Formato da un'unica unità ripetibile potenzialmente all'infinito, Caos è un intreccio di linee orizzontali e verticali volte a creare un disegno astratto. La struttura modulare consente sviluppare il portabottiglie in orizzontale o in verticale ed arredare pareti di qualsiasi dimensioni. In alternativa, Caos può essere dotato di mensole in legno da utilizzare come porta oggetti, diventando così in un bellissimo complemento d'arredo per il soggiorno.

Caos is a modern wall-mounted bottles holder and a fantastic decorative elements to add to yu house. It is made of a single unit that can be endlessly repeated. Caos is a twist of horixzontal and vertical lines that designs an abstract shape. The modular structure allows you to vertically or horizontally develop the bottles holder to decor any type of walls. Alternatively Caos can be equipped with small wooden shelves and become a beautiful livingroom accessory.

Геометрический и живой, упорядоченный и хаотичный, простой и функциональный, это Хаос, металлический стелаж, который, не только упорядочит Ваши бутылки, но и украсит дом с современным вкусом. Его система крепления позволяет легкую и быструю сборку, а также возможность компоновки нескольких модулей для украшения стены по Вашему желанию.



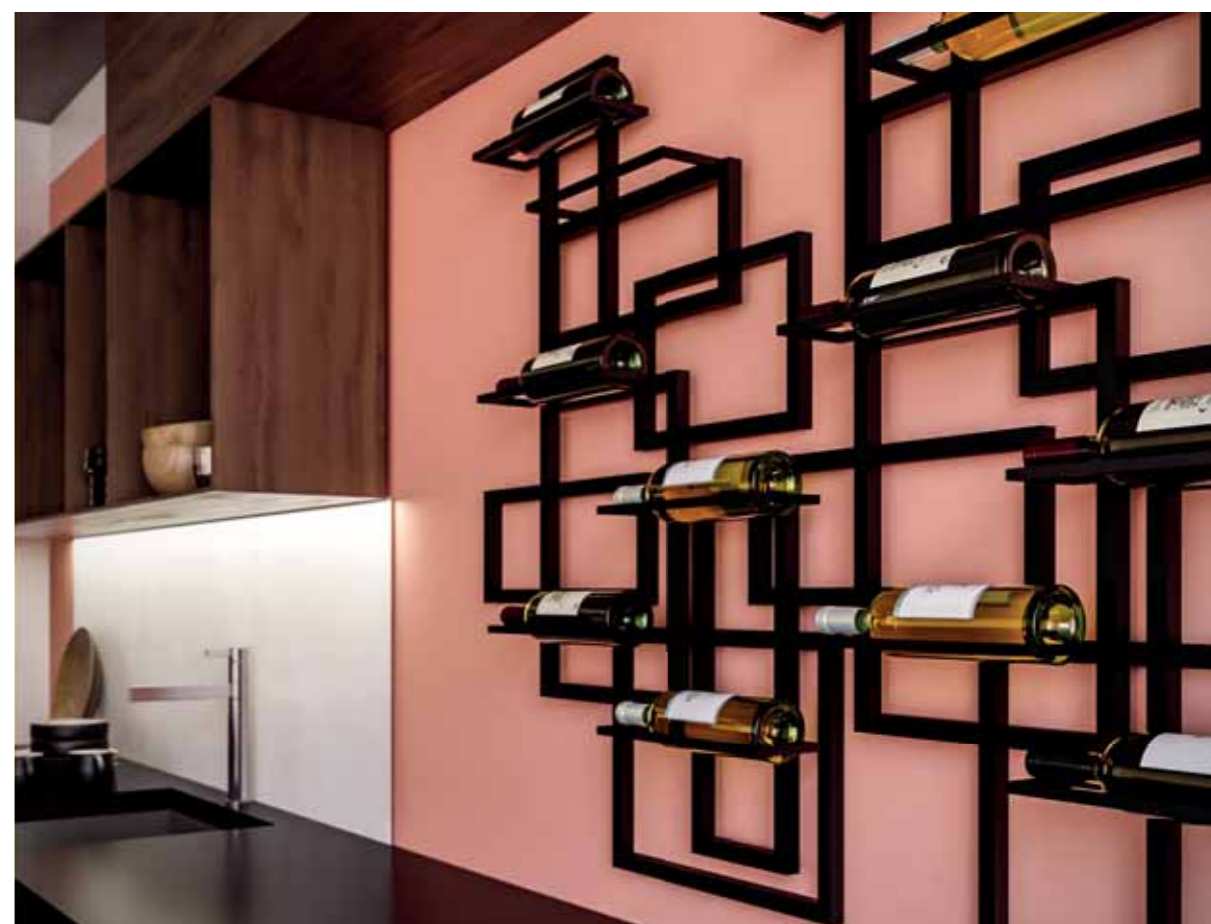
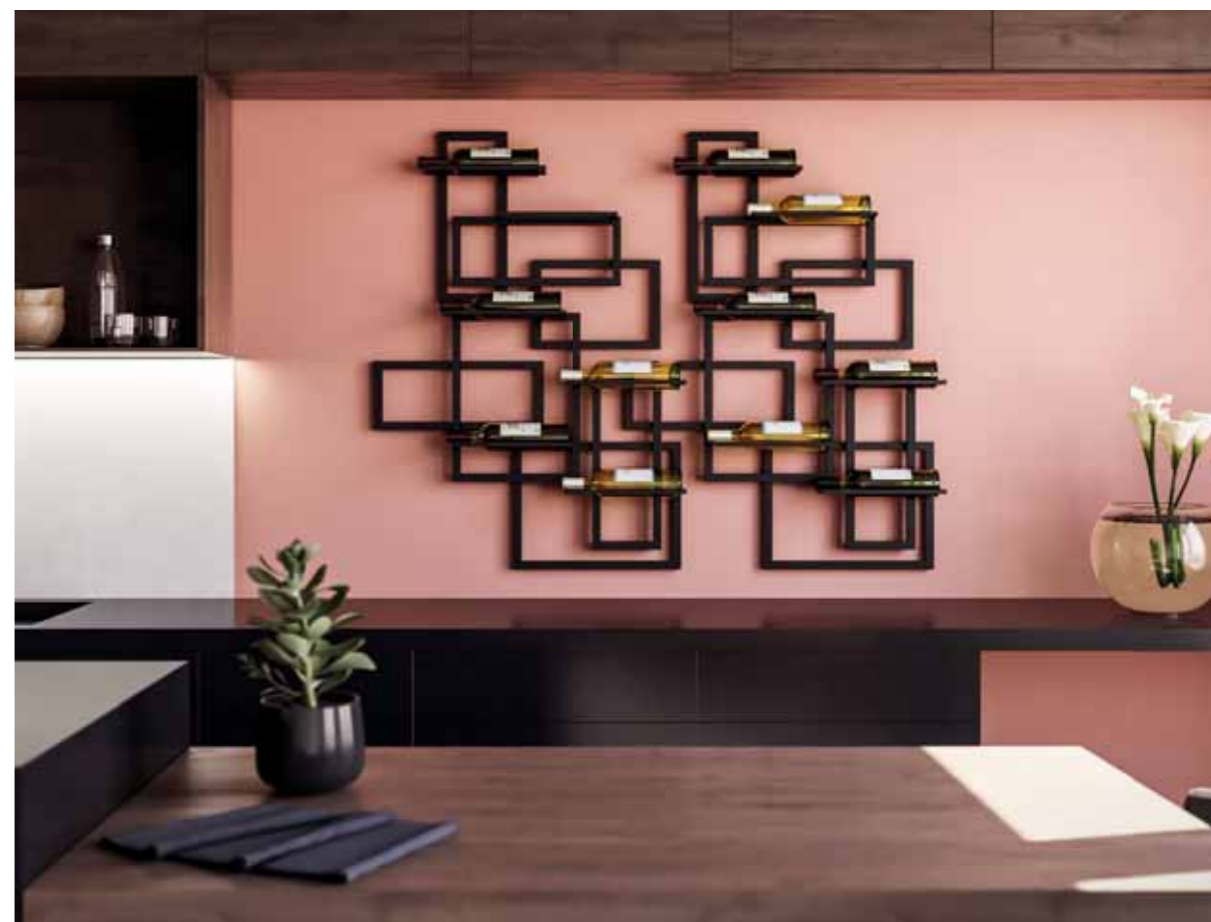

CAOS

Materiale / Materials / МАТЕРИАЛ
Ferro / Iron / Железо

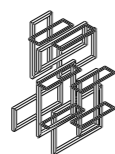

CAOS	
Kg.	13.0
L cm	77.0
H cm	108.5
P cm	13.0

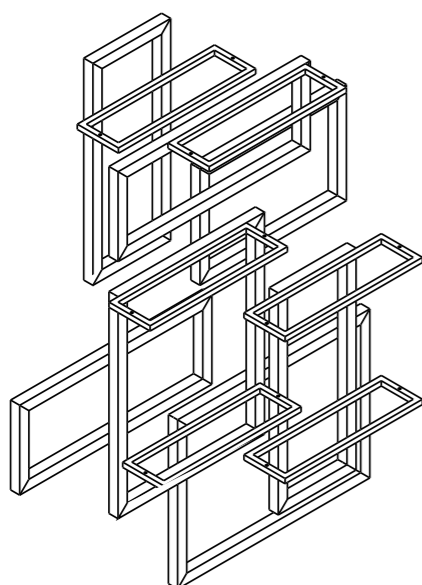

FINITURE / FINISHES / Покрытие

■ Nero / Black / черный

Mensola / Shelf / полка

Materiale / Materials / МАТЕРИАЛ
Legno / Wood / Дерево

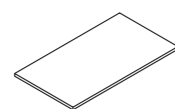

CAOS-SHELF	
Kg.	1.6
L cm	32.0
H cm	1.8
P cm	15.0

FINITURE / FINISHES / Покрытие

■ Rovere / durmast / дуб

Schema composizioni / Configuration / Схема композиции

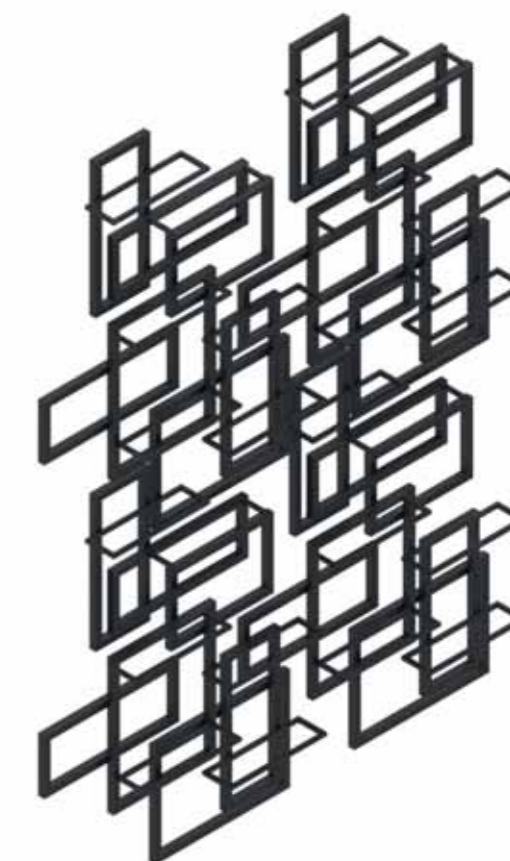
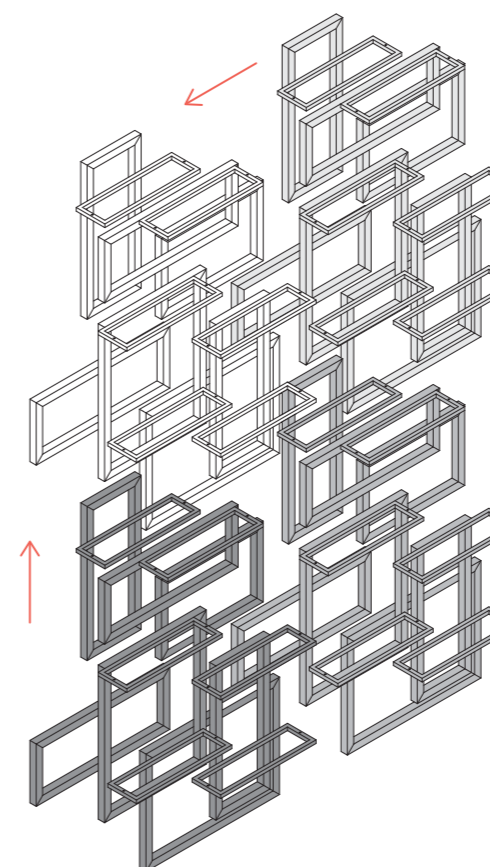
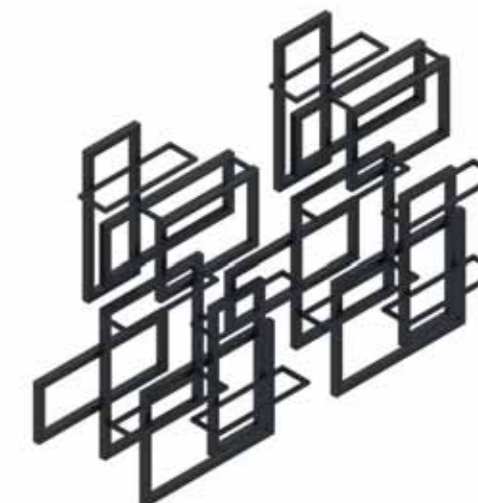
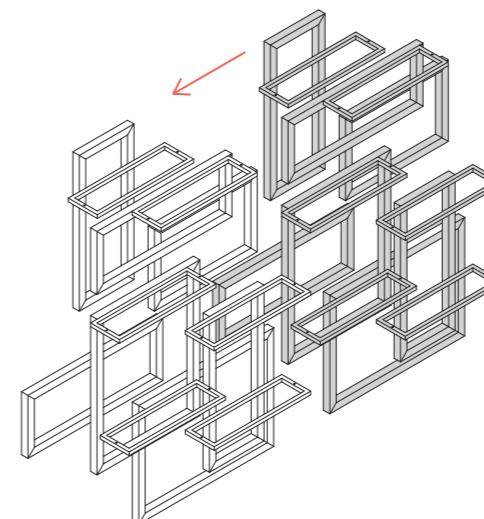

TRIGA

Con il suo design moderno e lineare, Triga è concepito per essere allo stesso tempo funzionale ed essenziale: oltre ai ganci universali, alle mensole e al portarotolo, collocabili nell'ordine preferito, ha un sistema di illuminazione con luce led ed una scatola con prese elettriche e USB che permette di collegare facilmente qualsiasi dispositivo. Un tocco di razionalità in cucina.

Design modern and linear. Triga is thought to be functional yet minimalist. It comes with universal hooks, shelves and a kitchen roll holder that you can place in your preferred order. In addition, it has a LED lighting system and both electric and USB sockets to easily connect any device. A touch of rationality in the kitchen.

Трига благодаря своему современному и линейному дизайну, была задумана чтобы быть функциональной и незаменимой: помимо универсальных крючков, полок и держателя для бумажного полотенца, которые размещаются на рейлинге в любом порядке, может быть дополнена освещением ЛЕД, встроенным трансформатором в удобную коробку-подставку, снабжённую практичными розетками и выходом USB. Это нота рациональности на кухне





TRIGA

Materiale / Materials / МАТЕРИАЛ
Alluminio / Aluminium / Алюминий

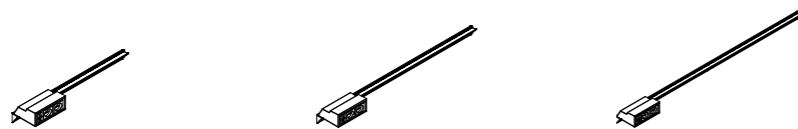

	TRIGA 600	TRIGA 900	TRIGA 1200
Kg.	1.1	1.4	1.6
L cm	60.6	90.6	120.6
H cm	10.5	10.5	10.5
P cm	12.5	12.5	12.5

FINITURE / FINISHES / Покрытие

 Ghisa / Cast iron / чугун

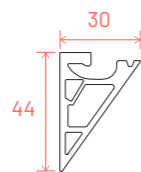
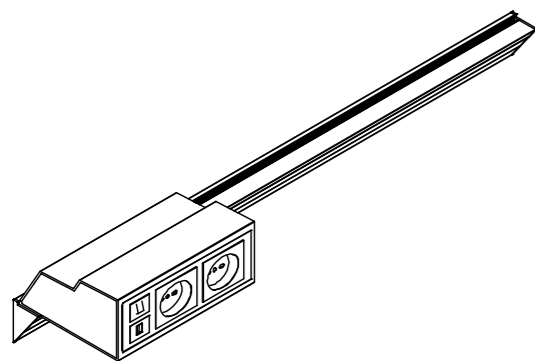

u = mm

LED

230 V



CE

ILLUMINAZIONE

Il box elettrico comprende 2 prese schuko, una porta USB ed un interruttore On/Off per poter accendere e spegnere la luce. Questo pratico e funzionale accessorio, grazie alla sua particolare sezione, funziona anche da leggio / porta tablet.

The electric box includes 2 schuko sockets, a USB port, and an On / Off switch to turn the light on and off. Thanks to its peculiar surface, this practical and functional accessory, works as a book stand / tablet holder too.

Электрическая коробка включает 2 розетки SHUKO, вход USB, и выключатель ON/OFF, который включает и выключает освещение. Этот практичный и функциональный аксессуар благодаря своей ступенчатой форме служит как держатель для планшета или книги.
Номер патента 002816751-0001

Accessori / Accessories / Аксессуары

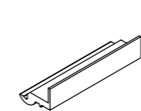

Adattatore
Adapter
адаптор
pagina 195

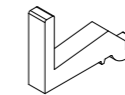

Gancio
Hook
крючок
pagina 194

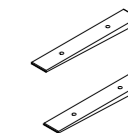

Reggimensola
Shelf support
полкодержатель
pagina 194

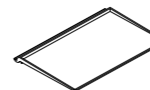

Mensola 270
Shelf 270
полка 270
pagina 192



Mensola 450
Shelf 450
полка 450
pagina 192

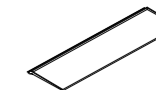

Mensola 600
Shelf 600
полка 600
pagina 192

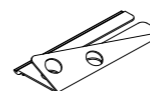

Portabottiglie
Bottle holder
держатель для
бутылок
pagina 195

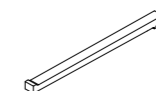

Portapentole
Pots hook
держатель для
кастрюль
pagina 193

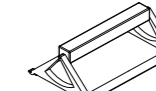

Portarotolo
Roll holder
держатель для
бумажного полотенца
pagina 193



TRIGA SLIM

Variante più semplice e compatta di Triga, perché priva della parte elettrica e dell'illuminazione, ne mantiene il design moderno e lineare, oltre a tutti gli accessori in dotazione: i ganci universali, le mensole e il portarotolo, sempre collocabili nell'ordine che si preferisce. Le sue dimensioni ridotte lo rendono perfetto anche per cucine piccole o su misura.

A smaller and more compact version of Triga, because it lacks the electric device and the lighting. However, it keeps its modern and linear design and it comes with all the original accessories: universal hooks, shelves and kitchen holder, to arrange as you prefer. Thanks to its size it is perfect even for small or bespoke kitchens.

Более компактная и простая версия Трига. Она не имеет электрической коробки и освещения, но сохраняет линейный и современный дизайн, а также все необходимые аксессуары: универсальные крючки, полки, держатель для бумажного полотенца, которые всегда можно разместить в любимом порядке. Уменьшенный размер Трига Слим, делают ее идеальной даже для маленьких или кухонь под заказ.







TRIGA SLIM

Materiale / Materials / МАТЕРИАЛ
Alluminio / Aluminium / Алюминий

	TRIGA SLIM 600	TRIGA SLIM 900	TRIGA SLIM 1200
Kg.	0.4	0.5	0.6
L cm	60.4	90.4	120.4
H cm	2.2	2.2	2.2
P cm	2.0	2.0	2.0

FINITURE / FINISHES / Покрытие

-  Ghisa / Cast iron / чугун
-  Bianco / White / белый

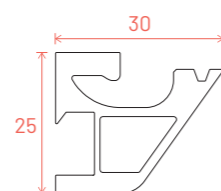
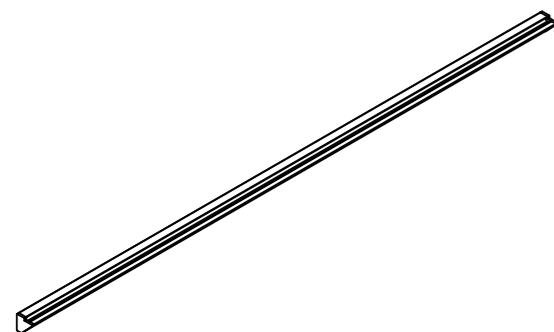

u = mm







Il sottopensile più sottile della gamma Damiano Latini. Con solo 2 cm di altezza sembra quasi scomparire nella parete lasciando gli accessori sospesi a mezz'aria. Le sue dimensioni ridotte lo rendono perfetto anche per cucine piccole o su misura.

The thinnest kitchen rack among Damiano Latini collection. It is only 2 cm high and it nearly disappears into the wall leaving the accessories suspended in the air. Little in size it is perfect for small or custom kitchens.

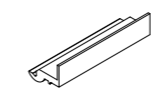
Самый тонкий рейлинг из коллекции Дамиано Латини. Он высотой всего 2 см, практически испаряется на стене, оставляя аксессуары, словно подвешенными в воздухе. Уменьшенные размеры делают его идеальным для маленьких и кухонь под заказ

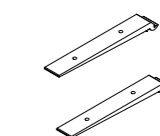

Accessori / Accessories / Аксессуары

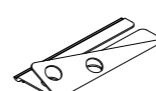
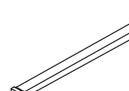
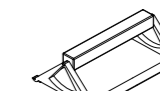
	Adattatore Adapter адаптор pagina 195		Gancio Hook крючок pagina 194		Reggimensola Shelf support полкодержатель pagina 194
	Mensola 270 Shelf 270 полка 270 pagina 192		Mensola 450 Shelf 450 полка 450 pagina 192		Mensola 600 Shelf 600 полка 600 pagina 192
	Portabottiglie Bottle holder держатель для бутылок pagina 195		Portapentole Pots hook держатель для кастрюль pagina 193		Portarotolo Roll holder держатель для бумажного полотенца pagina 193



PRATIKA

Pratika di nome e di fatto. Ma non solo: bella, colorata, decisamente pop! Disponibile in molte forme e colori, è in grado di rendere la tua cucina uno spazio confortevole e funzionale, grazie ai contenitori rimovibili che puoi decidere di appendere sulla barra metallica o lasciare in tavola, pronti all'uso.

Useful and multitasking yet beautiful, colourful, definitely pop! You can create your own Pratika choosing among different shapes and colours to make your kitchen a cosy and functional space. You can decide to hang the removable containers on the bar or leave them on the table ready to use.

Пратика – название говорит само за себя. Но не только – красивый, цветной, это однозначно рейлинг поп! Он доступный в разных формах и цветах, может превратить Вашу кухню в комфортное и функциональное помещение. Съёмные контейнеры можно, или вешать на рейлинг, или оставлять на столе и использовать





PRATIKA

Materiale / Materials / МАТЕРИАЛ
Alluminio / Aluminium / Алюминий

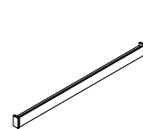

PRATIKA 600



PRATIKA 900

Kg.	0.4	0.5
L cm	60.5	90.5
H cm	4.0	4.0
P cm	2.2	2.2

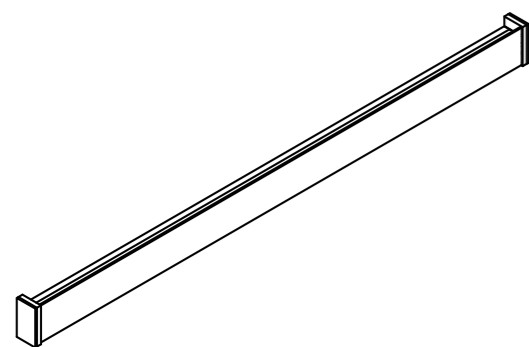

FINITURE / FINISHES / Покрытие

- Anodizzato lucido / Polished anodized / гляцевое анодирование
- Anodizzato spazzolato / Brushed anodized / шлифованное анодирование
- Nero / Black / черный

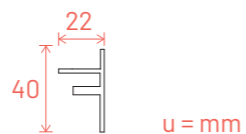

Accessori / Accessories / Аксессуары

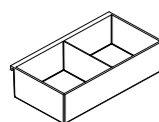

Portabarattoli
Jars holder
держатель для баночек

pagina 186

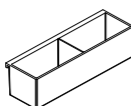

Portaspeszie
Spices holder
держатель для специй

pagina 186

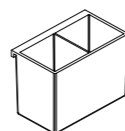

Portaposate
Cutlery holder
держатель для столовых приборов

pagina 186



Gancio
Hook
крючок

pagina 187

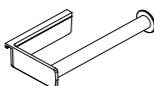

Portarotolo
Roll holder
держатель для бумажного полотенца

pagina 187



PRONTI ALL'USO

Pratika è in grado di rendere la tua cucina uno spazio confortevole grazie ai contenitori di plastica rimovibili che puoi decidere di appendere sulla barra metallica o lasciare in tavola, pronti all'uso.

Pratika and its removable plastic containers make your kitchen a comfortable space. You can decide to hang them on the metal bar or leave the table ready to use.

Практика может сделать твою кухню комфортным местом благодаря съёмным пластиковым контейнерам, которые можно по желанию повесить на металлический рейлинг или оставить на столе, готовы к использованию.

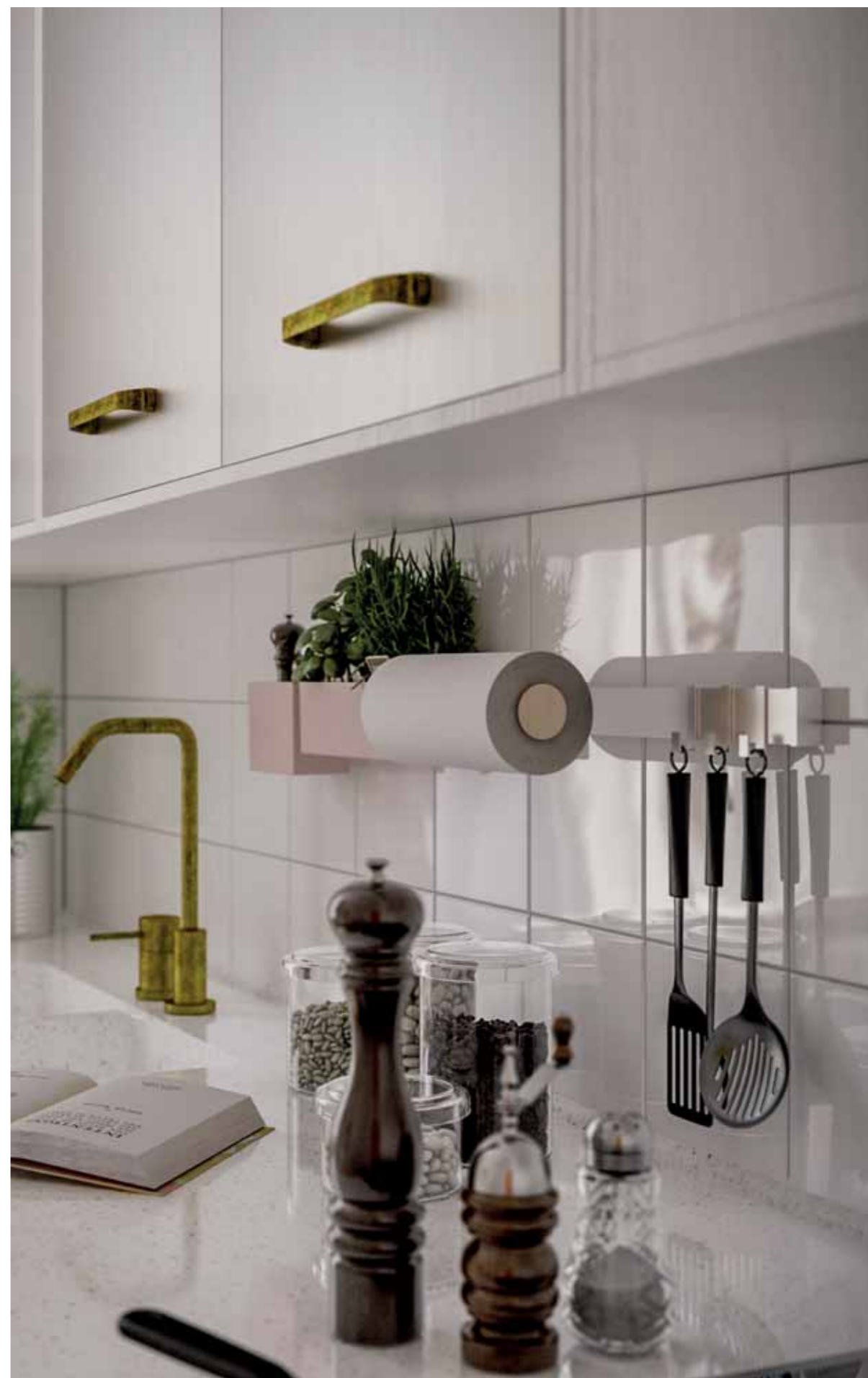

COMPACT

In cucina, chi non ha mai desiderato avere tutto a disposizione senza dover aprire mobili o cassetti? Grazie a Compact e alla sua struttura in metallo e ceramica componibile, potrai riporre in un attimo le posate e utilizzarle immediatamente per la cena o spostare il rotolo dalla parete direttamente sulla tavola.

Who doesn't wish a kitchen with everything available without having to open furniture or drawers? Thanks to Compact and its metal and ceramic modular structure, you can store your cutlery and have them ready for dinner or move the kitchen roll from the wall directly to the table.

Кто бы ни хотел иметь все под рукой на кухне без надобности открывать шкафы и ящики? Благодаря Компакт и его componuемой структуре из металла и керамики, можно мгновенно взять столовые приборы и использовать для сервировки ужина, или переместить бумажное полотенце со стены на стол.





COMPACT

Materiale / Materials / МАТЕРИАЛ
Alluminio / Aluminium / Алюминий



COMPACT 600



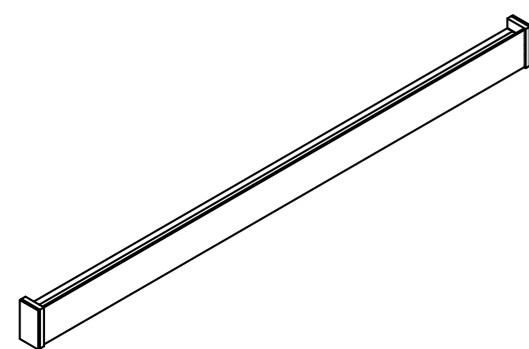

COMPACT 900

Kg.	0.4	0.5
L cm	60.5	90.5
H cm	4.0	4.0
P cm	2.2	2.2



FINITURE / FINISHES / Покрытие

-  Anodizzato lucido / Polished anodized / гляцевое анодирование
-  Anodizzato spazzolato / Brushed anodized / шлифованное анодирование
-  Nero / Black / черный

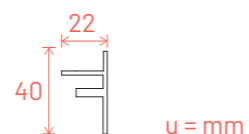

Accessori / Accessories / Аксессуары

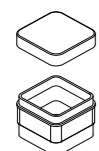

Contentori
Containers
контейнеры
pagina 188

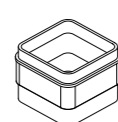

Contentori
Containers
контейнеры
pagina 188

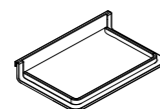

Mensola
Shelf
полка
pagina 188

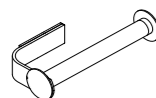

Portarotolo
Roll holder
держатель для
бумажного полотенца
pagina 189

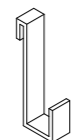

Gancio
Hook
крючок
pagina 187



PRONTI ALL'USO

Compact è in grado di rendere la tua cucina uno spazio confortevole grazie ai contenitori rimovibili che puoi decidere di appendere sulla barra metallica o lasciare in tavola, pronti all'uso.

Compact makes your kitchen an enjoyable space thanks to its removable containers that you can decide to hang on the on the metal bar or leave it on the table, ready to use.

Компакт может сделать твою кухню комфортным местом благодаря съёмным пластиковым контейнерам, которые можно по желанию повесить на металлический рейлинг или оставить на столе, готовы к использованию.



MONDRIAN

Colorato, resistente, mobile: è davvero impossibile resistere a Mondrian! Adatto sia alla cucina che allo studio o all'ufficio, grazie alla sua estrema versatilità permette di creare bellissime composizioni a parete o di organizzare in maniera pratica e funzionale superfici da lavoro. Composto da strutture in metallo con aggiunta di inserti in metacrilato colorato, dà alla tua casa un'allure pop e una ventata di allegria.

Colourful, durable, movable. It's impossible to resist Mondrian! Suitable for both the kitchen and the office. As it is extremely versatile you can create beautiful compositions to hang to the wall or to tidy your desk. The coloured methacrylate inserts on the metal structure will give your home a pop allure and a whiff of cheerfulness.

Невозможно устоять перед Мондриан - цветным, прочным и мобильным рейлингом! Подходит как для кухни, так и для студии, или офиса. Благодаря своей универсальности позволяет создать красивые композиции на стене, или организовать в практичной и функциональной форме рабочую поверхность. Состоит из металлической основы со вставками из цветного пластика, придаст твоему дому ноту поп стиля и безусловно радость





MONDRIAN

Materiale / Materials / МАТЕРИАЛ
Alluminio / Aluminium / Алюминий

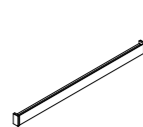



MONDRIAN 600



MONDRIAN 900

Kg.	0.4	0.5
L cm	60.5	90.5
H cm	4.0	4.0
P cm	2.2	2.2

FINITURE / FINISHES / Покрытие

-  Anodizzato lucido / Polished anodized / гляцевое анодирование
-  Anodizzato spazzolato / Brushed anodized / шлифованное анодирование
-  Nero / Black / черный

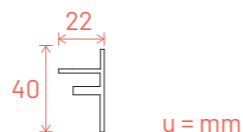
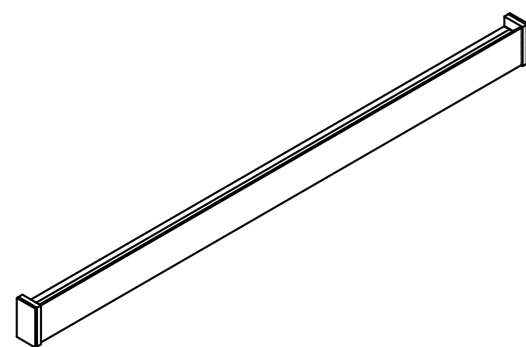

Accessori / Accessories / Аксессуары

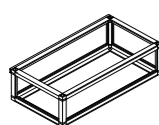

Portabarroli
Jars holder
держатель для баночек

pagina 190

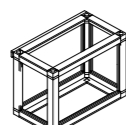

Portaposate
Cutlery holder
держатель для столовых приборов

pagina 190

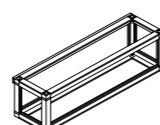

Portaspezie
Spices holder
держатель для специй

pagina 190

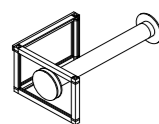

Portarotolo
Roll holder
держатель для бумажного полотенца

pagina 191

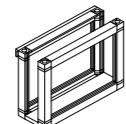

Portatovaglioli
Napkins holder
держатель для салфеток

pagina 191



Gancio
Hook
крючок

pagina 187



PRONTI ALL'USO

Mondrian è in grado di rendere la tua cucina uno spazio confortevole grazie ai contenitori rimovibili che puoi decidere di appendere sulla barra metallica o lasciare in tavola, pronti all'uso.

Mondrian will make your kitchen a comfortable space because of its removable containers that you can hang on the metal bar or leave on the table ready to use.

Мондриан может сделать твою кухню комфортным местом благодаря съёмным пластиковым контейнерам, которые можно по желанию повесить на металлический рейлинг или оставить на столе, готовые к использованию.



FIRKANT

Essenziale e facile da montare, Firkant è l'alleato più prezioso in cucina! Coltelli, spezie, presine, mestoli, cucchiari: c'è posto per tutto sulla sua sottile struttura in alluminio. E anche seguire le istruzioni di una ricetta diventa facile e divertente: grazie alla mensola applicabile e rimovibile, è infatti possibile appoggiare un tablet o qualsiasi altro oggetto serva in quel momento, persino una piantina che rallegri l'ambiente.

Minimalist and easy to assemble, Firkant is the most valuable ally in the kitchen! There is room for everything on its thin aluminium frame knife, spices, oven gloves, ladles and spoons. Trying new recipes becomes easy and fun by placing your tablet on the detachable shelf next to your favourite plant.

Простой и легкий при установке, Фиркан, это самый ценный помощник на кухне! Ножи, специи, прихватки, половники, ложки – есть место для всего на его тонкой алюминиевой структуре. Следовать рецепту станет просто и весело, благодаря съемной полке, на которую можно положить планшет или любой необходимый предмет, например растение, которое оживит помещение







FIRKANT

Materiale / Materials / МАТЕРИАЛ
Alluminio / Aluminium / Алюминий

	FIRKANT 600	FIRKANT 900	FIRKANT 1200
Kg.	0.4	0.6	0.7
L cm	60	90	120
H cm	3.4	3.4	3.4
P cm	1.1	1.1	1.1

FINITURE / FINISHES / Покрытие

-  Ghisa / Cast iron / чугун
-  Anodizzato lucido / Polished anodized / гляцевое анодирование
-  Anodizzato spazzolato / Brushed anodized / шлифованное анодирование

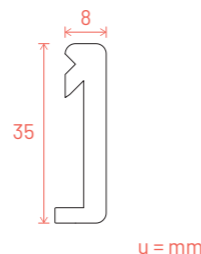
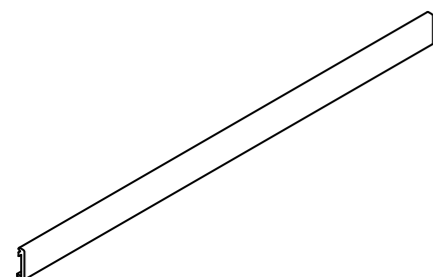



u = mm

Mensola / Shelf / полка

Materiale / Materials / МАТЕРИАЛ
Alluminio / Aluminum / Алюминий

	FRK02
Kg.	0.2
L cm	30.0
H cm	5.0
P cm	10.0

FINITURE / FINISHES / Покрытие



-  Ghisa / Cast iron / чугун
-  Anodizzato lucido / Polished anodized / гляцевое анодирование
-  Anodizzato spazzolato / Brushed anodized / шлифованное анодирование

Portaspezie / Spices holder
держатель для специй

Materiale / Materials / МАТЕРИАЛ
Alluminio-Plastica / Aluminum-Plastic / Алюминий-пластика

	FRK03
Kg.	0.5
L cm	30.0
H cm	5.0
P cm	10.0

FINITURE / FINISHES / Покрытие



-  Ghisa / Cast iron / чугун
-  Anodizzato lucido / Polished anodized / гляцевое анодирование
-  Anodizzato spazzolato / Brushed anodized / шлифованное анодирование

Magnete / Magnet / магнит

Materiale / Materials / МАТЕРИАЛ
Alluminio / Aluminum / Алюминий

	FRK04
Kg.	0.03
L cm	2.5
H cm	4.0
P cm	1.25

FINITURE / FINISHES / Покрытие



-  Ghisa / Cast iron / чугун
-  Anodizzato lucido / Polished anodized / гляцевое анодирование
-  Anodizzato spazzolato / Brushed anodized / шлифованное анодирование

Portaspezie / Spices holder
держатель для специй

Materiale / Materials / МАТЕРИАЛ
Alluminio-Plastica / Aluminum-Plastic / Алюминий-пластика

	FRK06
Kg.	0.3
L cm	30.0
H cm	5.0
P cm	10.0

FINITURE / FINISHES / Покрытие



-  Ghisa / Cast iron / чугун
-  Anodizzato lucido / Polished anodized / гляцевое анодирование
-  Anodizzato spazzolato / Brushed anodized / шлифованное анодирование

Portarotolo / Roll holder
Полка для бумажного

Materiale / Materials / МАТЕРИАЛ
Alluminio / Aluminum / Алюминий

	FRK01
Kg.	0.04
L cm	3.0
H cm	5.0
P cm	10.0

FINITURE / FINISHES / Покрытие



-  Ghisa / Cast iron / чугун
-  Anodizzato lucido / Polished anodized / гляцевое анодирование
-  Anodizzato spazzolato / Brushed anodized / шлифованное анодирование

Gancio / Hook / крючок

Materiale / Materials / МАТЕРИАЛ
Alluminio / Aluminum / Алюминий

	FRK05
Kg.	0.01
L cm	2.5
H cm	3.9
P cm	3.2

FINITURE / FINISHES / Покрытие

-  Ghisa / Cast iron / чугун
-  Anodizzato lucido / Polished anodized / гляцевое анодирование
-  Anodizzato spazzolato / Brushed anodized / шлифованное анодирование

HORIZON

Piccolo e compatto, Horizon organizza in modo pratico e razionale tutti gli strumenti da lavoro indispensabili in cucina: coltelli, utensili, spezie, ricettari, rotolo assorbente. Con la sua barra in alluminio disponibile in diverse finiture, si integra perfettamente sia agli ambienti di gusto più classico che a quelli moderni e minimali, rendendo agevole ogni tuo gesto e più piacevole la tua quotidianità in cucina.

Small and compact. Horizon organizes practically and efficiently all the indispensable work tools in the kitchen: knife, utensils, spices, books, kitchen rolls. Thanks to its aluminium bar available in different finishes, it fits perfectly into either classic or modern furnished spaces. It will help during your everyday life in the kitchen and it will make every moment more enjoyable.

Горизонт маленький и компактный рейлинг организует практично и рационально все важные инструменты для работы на кухне: ножи, специи, книги рецептов, бумажное полотенце. Его алюминиевый рейлинг, доступный в разных размерах и покрытиях, хорошо адаптируется как в классических, так и в минималистичных и современных помещениях. Он поможет облегчить каждое твое движение, и сделает более приятной повседневную работу на кухне.



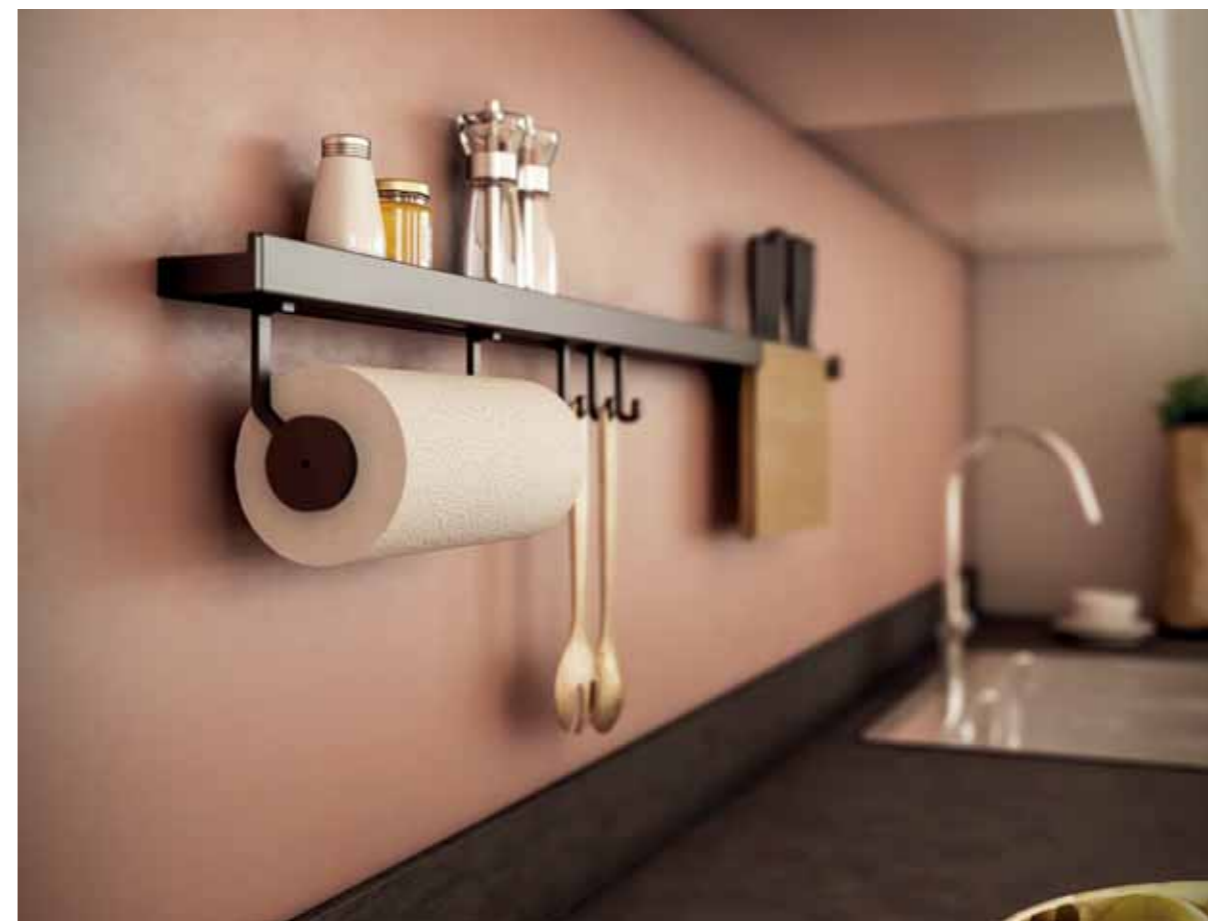
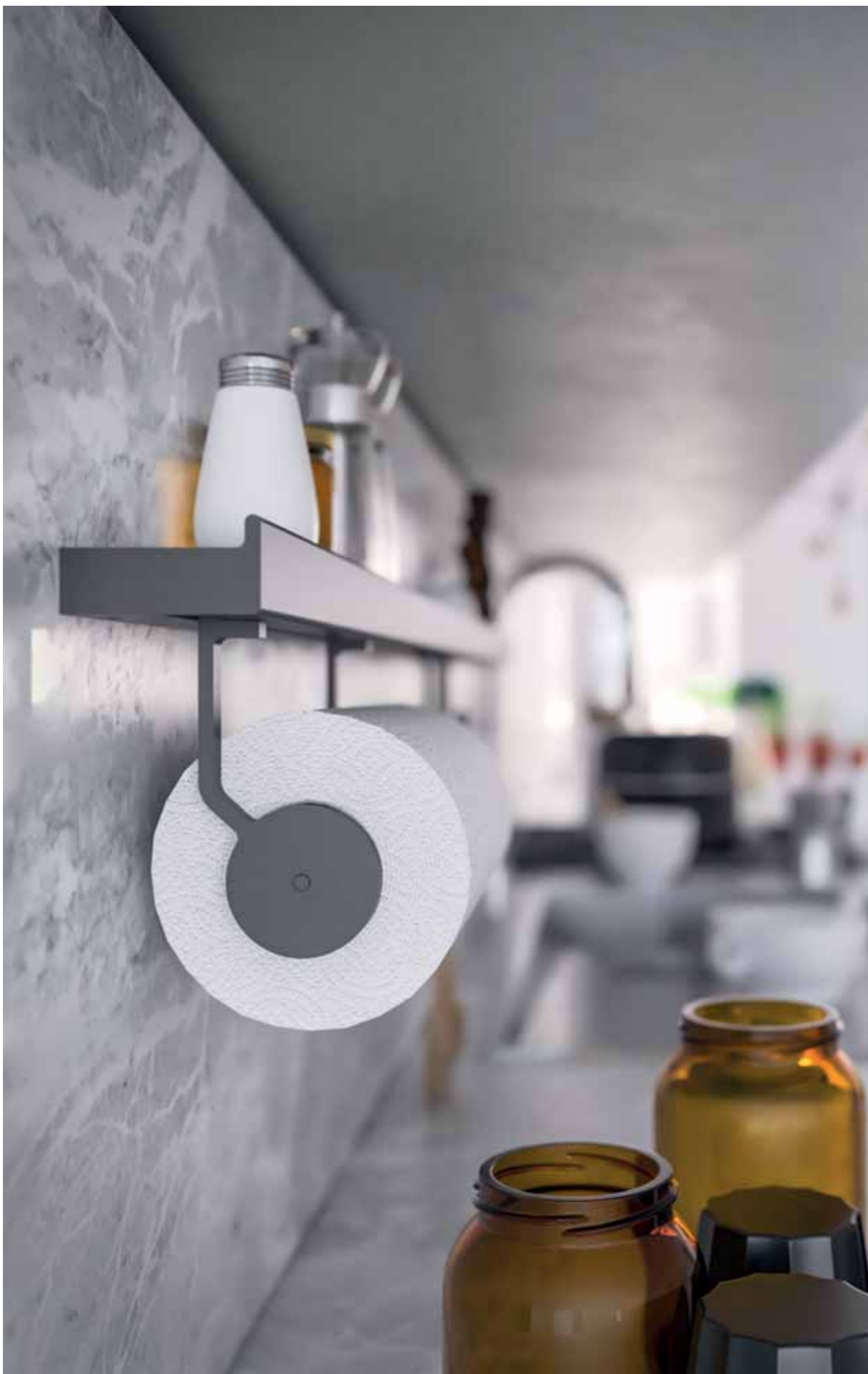





HORIZON

Materiale / Materials / МАТЕРИАЛ
Alluminio / Aluminium / Алюминий



	HORIZON 600	HORIZON 900	HORIZON 1200
Kg.	0.8	1.2	1.5
L cm	61.0	91.0	121.0
H cm	3.0	3.0	3.0
P cm	6.0	6.0	6.0

FINITURE / FINISHES / Покрытие

-  Ghisa / Cast iron / чугун
-  Anodizzato spazzolato / Brushed anodized / шлифованное анодирование
-  Nero / Black / черный
-  Oro antico / Antique gold / золото
-  Bronzo / Bronze / бронза

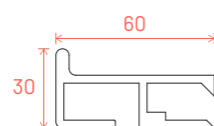
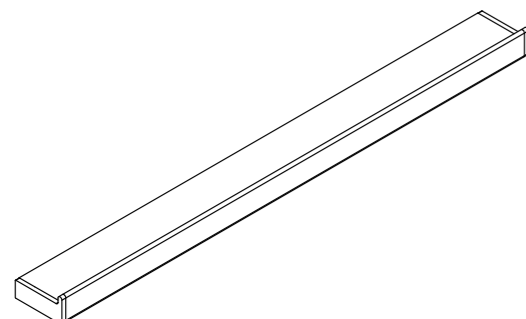

u = mm

Accessori / Accessories / Аксессуары

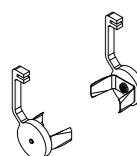

Portarotolo
Roll holder
держатель для
бумажного полотенца

pagina 201

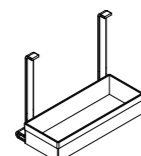

Porta spugne
Sponges holder
держатель для мочалок
и мыла

pagina 200

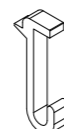

Gancio
Hook
крючок

pagina 201

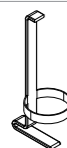

Porta dispenser
Soap dispenser holder
Держатель для жидкого
мыла

pagina 200





HORIZON T

Materiale / Materials / МАТЕРИАЛ
Alluminio / Aluminium / Алюминий



	HORIZON 900 T	HORIZON 1200 T
Kg.	1.8	2.1
L cm	91.0	121.0
H cm	3.0	3.0
P cm	6.0	6.0

FINITURE / FINISHES / Покрытие

-  Ghisa / Cast iron / чугун
-  Anodizzato spazzolato / Brushed anodized / шлифованное анодирование
-  Nero / Black / черный
-  Oro antico / Antique gold / золото
-  Bronzo / Bronze / бронза

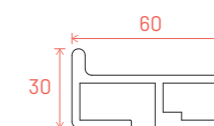
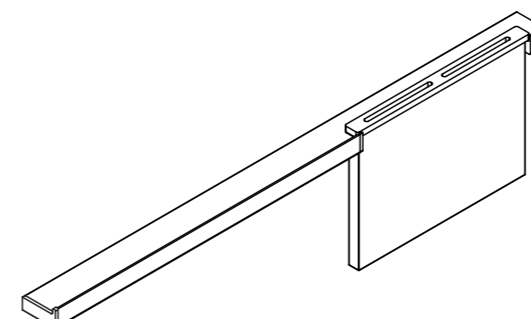

u = mm

Accessori / Accessories / Аксессуары

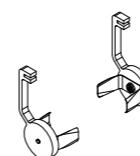

Portarotolo
Roll holder
держатель для
бумажного полотенца

pagina 201

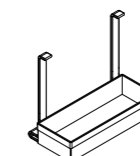

Porta spugne
Sponges holder
держатель для мочалок
и мыла

pagina 200



Gancio
Hook
крючок

pagina 201



Porta dispenser
Soap dispenser holder
Держатель для жидкого
мыла

pagina 200

HORIZON BIG

Grazie al suo ingombro ridotto e a un design semplice e minimale, Horizon big mantiene tutta la funzionalità del sottopensile a cui si ispira, ampliandone la struttura e adattandosi all'ambiente bagno in modo quasi invisibile: con i suoi comodi ganci e la sua sottile barra in metallo, disponibile in varie finiture, sarà facile ordinare gli oggetti indispensabili alla tua quotidianità come più ti piace, per averli sempre a portata di mano.

Thanks to its essential and minimalist design, Horizon Big keeps all the features of the original kitchen rack but with a larger structure adapted to completely merge into the bathroom area. Both the hooks and the thin metal bar can be personalised with different finishes to match with your bathroom style. A indispensable piece of furniture to have all you need always at your fingertips.

Горизонт Биг благодаря простому и минимальному дизайну, сохраняет все качества рейлинговой системы, но дополняет и адаптирует структуру для ванного помещения, практически незаметно. Удобные крючки и тонкая металлическая полка-рейлинг доступны в разных размерах. Станет совсем легко организовать незаменимые предметы твоей повседневной жизни и иметь их всегда под рукой

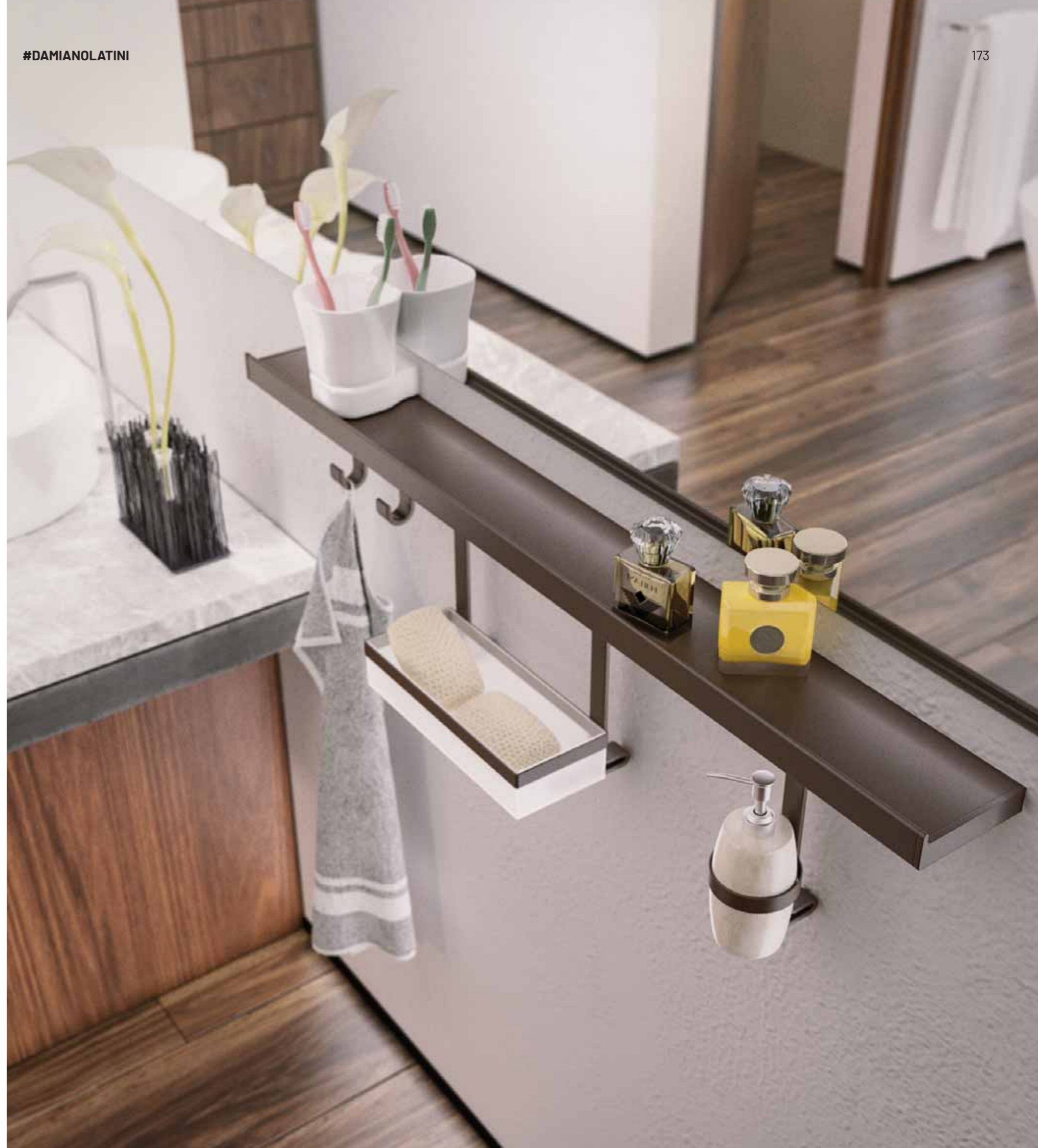





HORIZON BIG

Materiale / Materials / МАТЕРИАЛ
Alluminio / Aluminium / Алюминий



	HORIZON BIG 600	HORIZON BIG 900	HORIZON BIG 1200
Kg.	0.8	1.2	1.5
L cm	61.0	91.0	121.0
H cm	3.0	3.0	3.0
P cm	10.0	10.0	10.0

FINITURE / FINISHES / Покрытие

-  Ghisa / Cast iron / чугун
-  Anodizzato spazzolato / Brushed anodized / шлифованное анодирование

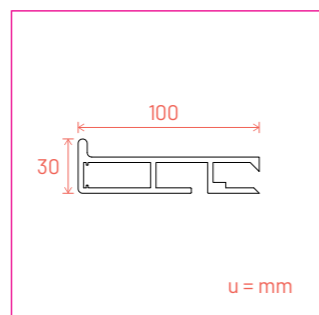
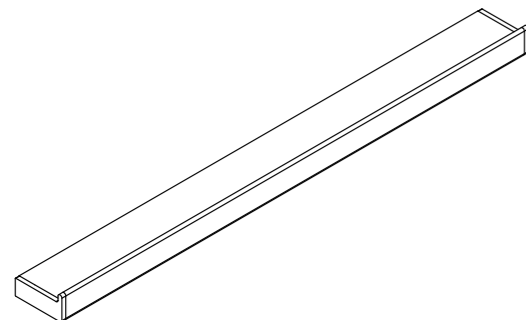

Accessori / Accessories / Аксессуары

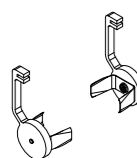

Portarotolo
Roll holder
держатель для
бумажного полотенца

pagina 201

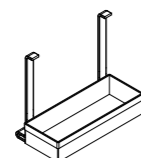

Porta spugne
Sponges holder
держатель для мочалок
и мыла

pagina 200

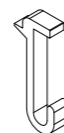

Gancio
Hook
крючок

pagina 201



Porta dispenser
Soap dispenser holder
Держатель для жидкого
мыла

pagina 200



RISE

Rise somma funzionalità ed eleganza, grazie al suo design minimalista. Si compone di diversi accessori che permettono di personalizzare la barra e integrarla all'ambiente di utilizzo. Estremamente versatile ed elegante ottimizza gli spazi e senza rinunciare all'estetica del design.

Rise adds functionality and elegance, thanks to its minimalist design. It consists of several accessories that allow you to customize and integrate it into the environment of use. Extremely versatile and elegant, it optimizes spaces without renouncing the design.

добавляет функциональность и элегантность благодаря минималистскому дизайну. Он состоит из нескольких аксессуаров, которые позволяют персонализировать панель и интегрировать ее в среду использования. Чрезвычайно универсальный и элегантный, он оптимизирует пространства, не теряя эстетики дизайна







RISE

Materiale / Materials / МАТЕРИАЛ
Alluminio / Aluminium / Алюминий

	RISE 900	RISE 1200	RISE 3100
Kg.	0.4	0.55	1.5
L cm	90.0	120.0	310.0
H cm	3.0	3.0	3.0
P cm	2.3	2.3	2.3

FINITURE / FINISHES / Покрытие

	RAL 7016
	Bianco / White / белый

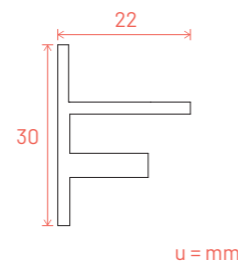
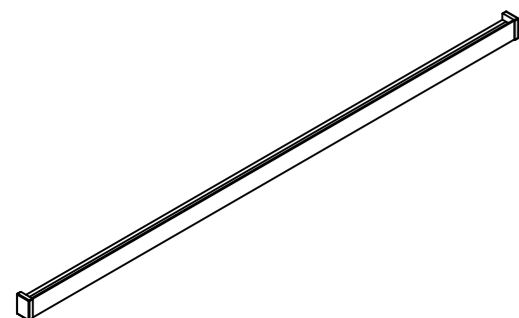

Mensola / Shelf / полка

Materiale / Materials / МАТЕРИАЛ
Alluminio / Aluminum / Алюминий

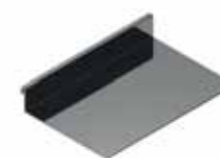
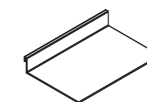

RISE-SH

Kg.	0.37
L cm	20.0
H cm	3.2
P cm	13.5

Mensola / Shelf / полка

Materiale / Materials / МАТЕРИАЛ
Alluminio / Aluminum / Алюминий

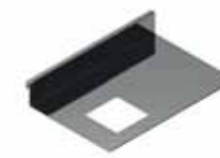
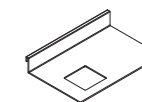

RISE-SH1

Kg.	0.35
L cm	20.0
H cm	3.2
P cm	13.5

Mensola / Shelf / полка

Materiale / Materials / МАТЕРИАЛ
Alluminio / Aluminum / Алюминий

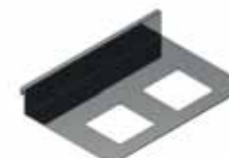
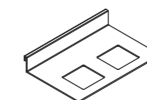

RISE-SH2

Kg.	0.33
L cm	20.0
H cm	3.2
P cm	13.5

Porta salviette / Towel bar
держатель салфеток

Materiale / Materials / МАТЕРИАЛ
Alluminio / Aluminum / Алюминий

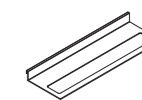

RISE-TH

Kg.	0.27
L cm	40.0
H cm	3.2
P cm	13.5

Portarotolo / Roll holder
Полка для бумажного

Materiale / Materials / МАТЕРИАЛ
Alluminio / Aluminum / Алюминий

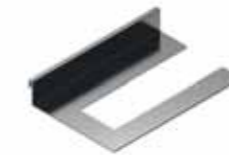
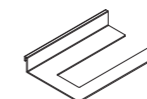

RISE-RH

Kg.	0.30
L cm	20.0
H cm	3.2
P cm	13.5

Porta tablet / Tablet holder
держатель для планшета

Materiale / Materials / МАТЕРИАЛ
Alluminio / Aluminum / Алюминий

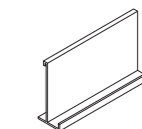

RISE-PT

Kg.	0.41
L cm	24.6
H cm	15.0
P cm	9.1

Porta cellulare / Phone holder
держатель для телефона

Materiale / Materials / МАТЕРИАЛ
Plexiglass / Plexiglas / Плексиглаз

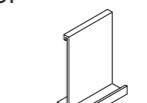

RISE-PC

Kg.	0.20
L cm	12.0
H cm	15.0
P cm	9.1

Bicchieri / Tumbler holder
контейнер для зубных щёток

Materiale / Materials / МАТЕРИАЛ
Acciaio / Steel / сталь

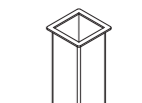

RISE-BI

Kg.	0.36
L cm	6.0
H cm	12.2
P cm	6.0

Dispenser / Dispenser
контейнер для мыла

Materiale / Materials / МАТЕРИАЛ
Acciaio / Steel / сталь

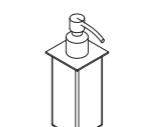

RISE-DI

Kg.	0.58
L cm	6.0
H cm	17.5
P cm	6.0

Porta sapone / Soap holder
держатель для мыла

Materiale / Materials / МАТЕРИАЛ
Acciaio / Steel / сталь



RISE-PS

Kg.	0.30
L cm	14.0
H cm	2.7
P cm	10.5

CREATIVE COMBOS

Può un dettaglio cambiare completamente lo stile di una casa? Certo, a patto che la sua presenza sia costante ma leggera, quasi impercettibile. Esattamente come quella dei nostri accessori. Differenti per design e usabilità, i nostri accessori sono il frutto di una ricerca accurata di materiali e forme, di studi di ergonomia e comfort, e sono pensati e realizzati perché ognuno possa dare il proprio tocco personale ai nostri prodotti.

Can a detail completely change the style of a home? Of course, provided that his presence is constant but light, almost imperceptible. Exactly like that of our accessories. Different for design and usability, our accessories are the result of a careful research of materials and shapes, studies of ergonomics and comfort, and are designed and made so that everyone can give their personal touch to our products.

Может ли деталь полностью изменить стиль дома? Конечно, при условии, что ее присутствие постоянно, но легко, почти незаметно. Именно такое, как у наших аксессуаров. Различные по дизайну и удобству использования, наши аксессуары являются результатом точного поиска материалов и форм, исследования эргономика и комфорта, а также спроектированы и построены так, чтобы каждый мог придать свою индивидуальность нашим продуктам

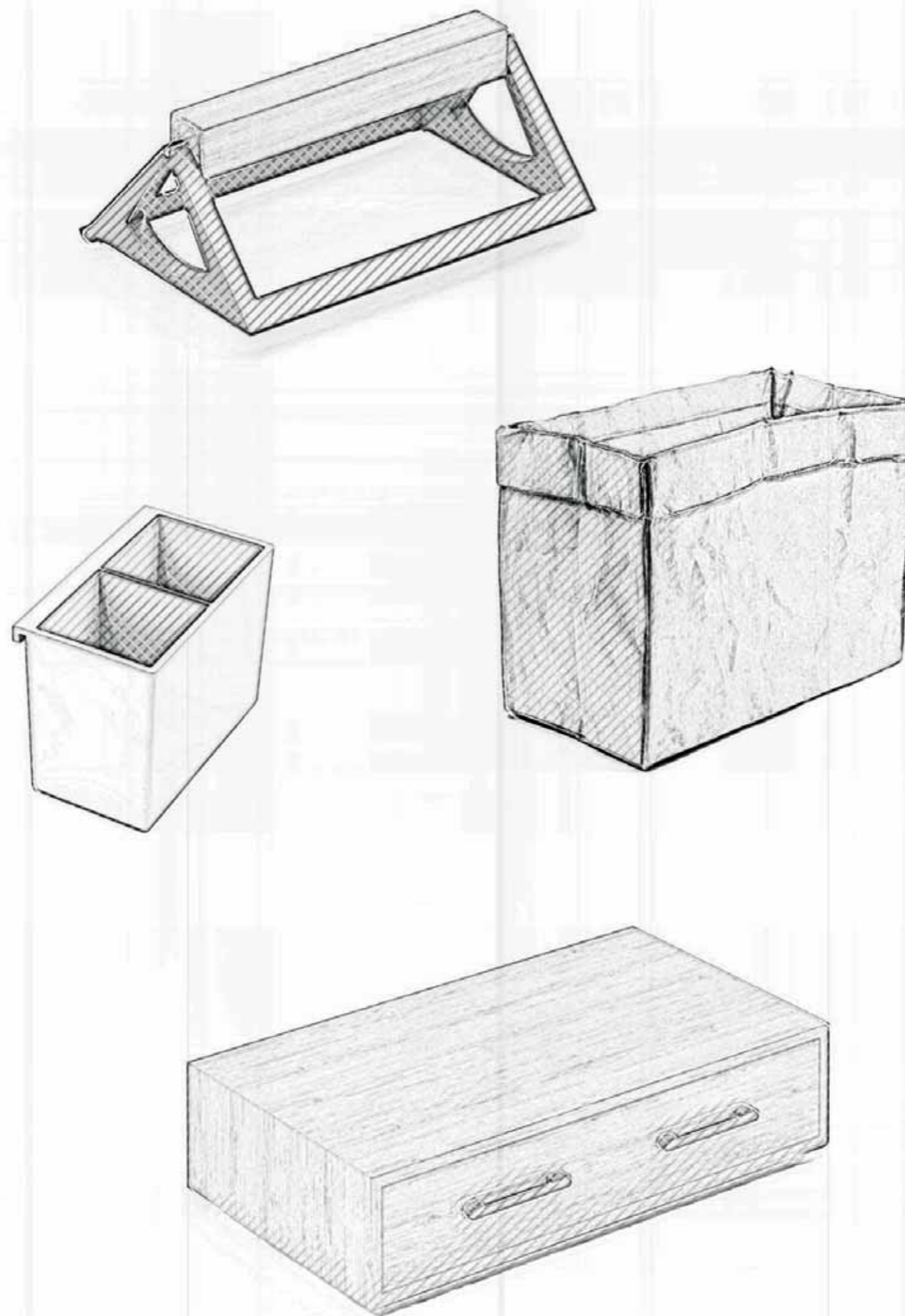

Portabarattoli / Jars holder / держатель для баночек

Materiale / Materials / МАТЕРИАЛ
Plastica / Plastic / Пластик

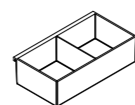
**P-AM02**

Kg.	0.4
L cm	27.0
H cm	7.5
P cm	14.7

Portaspezie / Spices holder / держатель для специй

Materiale / Materials / МАТЕРИАЛ
Plastica / Plastic / Пластик

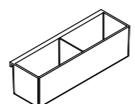
**P-AM03**

Kg.	0.2
L cm	27.0
H cm	7.5
P cm	8.2

Portaposate / Cutlery holder / держатель для столовых приборов

Materiale / Materials / МАТЕРИАЛ
Plastica / Plastic / Пластик

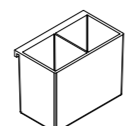
**P-AM04**

Kg.	0.2
L cm	13.0
H cm	10.0
P cm	7.5

Portarotolo / Roll holder / держатель для бумажного полотенца

Materiale / Materials / МАТЕРИАЛ
Plastica / Plastic / пластика

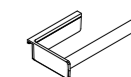

**P-AM05**

Kg.	0.2
L cm	24.5
H cm	4.5
P cm	12.1

Gancio / Hook / крючок

Materiale / Materials / МАТЕРИАЛ
Alluminio / Aluminum / Алюминий

FINITURE / FINISHES / Покрытие

-  Anodizzato lucido / Polished anodized / гляцевое анодирование
-  Anodizzato spazzolato / Brushed anodized / шлифованное анодирование

**AM06**

Kg.	0.005
L cm	1.0
H cm	5.2
P cm	1.7

FINITURE / FINISHES / Покрытие

-  Nero / Black / черный
-  Acquamarina / Aquamarine / аквамарин
-  Bianco / White / белый
-  Rosso corallo / Coral red / красный корал
-  Vulcano / Volcan / серый вулкан
-  Giallo ambra / Amber / желтый янтарь
-  Bruno antilope / Antelope brown / бежевый
-  Salvia / Sage / зеленый
-  Ghisa / Cast iron / чугун
-  Rosa quarzo / Quartz pink / розовый кварц

APPLICAZIONI / APPLICATIONS / Применения

-  GIOSTRA
-  DAMA
-  DAMA L
-  TRIGA
-  PRATIKA
-  TRIGA SLIM

Contenitori / Containers / контейнеры

Materiale / Materials / МАТЕРИАЛ
Zama-Ceramica / Zamak-Ceramic / ЗАМАК – керамика

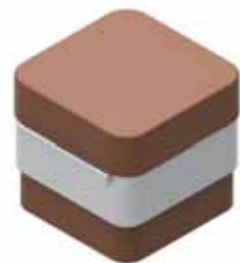

CPT01

Kg.	1.1
L cm	11.2
H cm	11.0
P cm	11.2

Contenitori / Containers / контейнеры

Materiale / Materials / МАТЕРИАЛ
Zama-Ceramica / Zamak-Ceramic / ЗАМАК – керамика

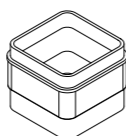

CPT02

Kg.	0.9
L cm	11.2
H cm	11.0
P cm	11.2

Mensola / Shelf / полка

Materiale / Materials / МАТЕРИАЛ
Zama-Ceramica / Zamak-Ceramic / ЗАМАК – керамика

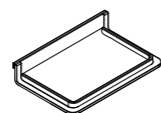

CPT04

Kg.	0.9
L cm	21.9
H cm	4.0
P cm	14.0

Portarotolo / Roll holder / держатель для бумажного полотенца

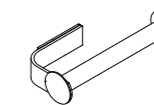

Materiale / Materials / МАТЕРИАЛ
Zama-Plexiglass / Zamak-Plexiglas / ЗАМАК – Плекси стекло





CPT03

Kg.	0.5
L cm	25.0
H cm	6.0
P cm	12.0

FINITURE STRUTTURA / STRUCTURE FINISHING / покрытия структуры

-  Cromo lucido / Polish chrome / хром глянец
-  Cromo satinato / Sateen chrome / хром матовый

FINITURE ACCESSORI / ACCESORIES FINISHING / аксессуаров

-  Bianco / White / белый
-  Cream / Cream / бежевый
-  Caffè / Coffee / кофе

APPLICAZIONI / APPLICATIONS / Применения

-  GIOSTRA
-  DAMA
-  DAMA L
-  TRIGA
-  COMPACT
-  TRIGA SLIM

Portabarattoli / Jars holder / держатель для баночек

Materiale / Materials / МАТЕРИАЛ
Zama-Plexiglass / Zamak-Plexiglas / ЗАМАК – Плекси стекло

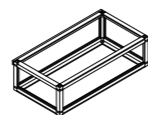
**AM02**

Kg.	0.9
L cm	27.0
H cm	7.5
P cm	14.0

Portaspezie / Spices holder / держатель для специй

Materiale / Materials / МАТЕРИАЛ
Zama-Plexiglass / Zamak-Plexiglas / ЗАМАК – Плекси стекло

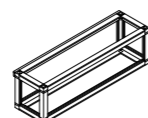
**AM03**

Kg.	0.7
L cm	26.0
H cm	7.5
P cm	7.0

Portaposate / Cutlery holder / держатель для столовых приборов

Materiale / Materials / МАТЕРИАЛ
Zama-Plexiglass / Zamak-Plexiglas / ЗАМАК – Плекси стекло

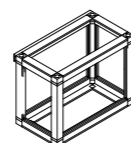
**AM04**

Kg.	0.5
L cm	13.0
H cm	10.0
P cm	7.0

Portatovaglioli / Napkins holder / держатель для салфеток

Materiale / Materials / МАТЕРИАЛ
Zama-Plexiglass / Zamak-Plexiglas / ЗАМАК – Плекси стекло

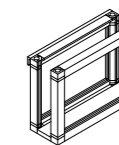
**AM01**

Kg.	0.4
L cm	12.0
H cm	9.0
P cm	4.3

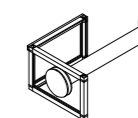

Portarotolo / Roll holder / держатель для бумажного полотенца

Materiale / Materials / МАТЕРИАЛ
Zama-Plexiglass / Zamak-Plexiglas / ЗАМАК – Плекси стекло

**AM06**

Kg.	0.6
L cm	24.5
H cm	10.0
P cm	15.0







FINITURE STRUTTURA / STRUCTURE FINISHING / покрытия структуры

-  Cromo lucido / Polish chrome / хром глянцевый
-  Cromo satinato / Sateen chrome / хром матовый

FINITURE PLEXIGLASS / PLEXIGLASS FINISHING / Покрытия

-  Blu lucido / Shiny blue / синий глянцевый
-  Blu opaco / Matte blue / синий матовый
-  Giallo / Yellow / желтый
-  Giallo ambra / Amber / желтый янтарь
-  Ghiaccio / Ice / лёд
-  Lime / Lime / лайм
-  Nero / Black / черный
-  Rosso / Red / красный
-  Sabbia / Sand / песок
-  Caffè / Coffee / кофе

APPLICAZIONI / APPLICATIONS / Применения

-  GIOSTRA
-  DAMA
-  DAMA L
-  TRIGA
-  MONDRIAN
-  TRIGA SLIM

Mensola / Shelf / полка

Materiale / Materials / МАТЕРИАЛ
Alluminio / Aluminum / Алюминий

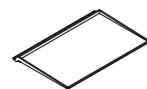

GIOSTRA/S-270

Kg.	0.4
L cm	27.0
H cm	1.0
P cm	17.0

Mensola / Shelf / полка

Materiale / Materials / МАТЕРИАЛ
Alluminio / Aluminum / Алюминий



GIOSTRA/S-450

Kg.	0.8
L cm	45.0
H cm	1.0
P cm	17.0

Mensola / Shelf / полка

Materiale / Materials / МАТЕРИАЛ
Alluminio / Aluminum / Алюминий



GIOSTRA/S-600

Kg.	1.1
L cm	60.0
H cm	1.0
P cm	17.0

Portarotolo / Roll holder / держатель для бумажного полотенца

Materiale / Materials / МАТЕРИАЛ
Alluminio-Legno / Aluminum-Wood / Алюминий-Дерево

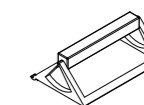

GIOSTRA-RH

Kg.	0.5
L cm	27.2
H cm	8.4
P cm	17.0

Portapentole / Pots hook / держатель для кастрюль



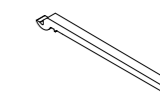

Materiale / Materials / МАТЕРИАЛ
Alluminio / Aluminum / Алюминий







GIOSTRA/PH

Kg.	0.03
L cm	1.0
H cm	0.8
P cm	16.3

FINITURE / FINISHES / Покрытие

	Ghisa / Cast iron / чугун
	Titanio / Titanium / титан
	Nero / Black / черный
	Bianco / White / белый

APPLICAZIONI / APPLICATIONS / Применения

	GIOSTRA
	DAMA
	DAMA L
	TRIGA
	TRIGA SLIM

Reggimensola / Shelf support / полкодержатель

Materiale / Materials / МАТЕРИАЛ
Alluminio / Aluminum / Алюминий

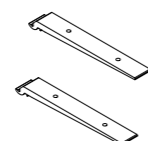

GIOSTRA/SH

Kg.	0.1
L cm	3.0
H cm	1.3
P cm	20.0

Gancio / Hook / крючок



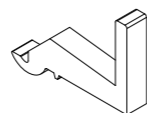

Materiale / Materials / МАТЕРИАЛ
Alluminio / Aluminum / Алюминий



GIOSTRA/H

Kg.	0.03
L cm	1.0
H cm	3.9
P cm	5.3

FINITURE / FINISHES / Покрытие

	Ghisa / Cast iron / чугун
	Titanio / Titanium / титан
	Nero / Black / черный
	Bianco / White / белый

APPLICAZIONI / APPLICATIONS / Применения

	GIOSTRA
	DAMA
	DAMA L
	TRIGA
	TRIGA SLIM

Adattatore / Adapter / адаптор

Materiale / Materials / МАТЕРИАЛ
Alluminio / Aluminum / Алюминий

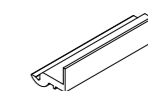

GIOSTRA/A

Kg.	0.05
L cm	10.0
H cm	2.0
P cm	2.3

Portabottiglie / Bottle holder / держатель для бутылок



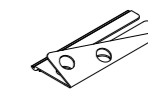

Materiale / Materials / МАТЕРИАЛ
Alluminio / Aluminum / Алюминий







GIOSTRA/WH

Kg.	0.3
L cm	27.0
H cm	4.5
P cm	10.0

FINITURE / FINISHES / Покрытие

	Ghisa / Cast iron / чугун
	Titanio / Titanium / титан
	Nero / Black / черный
	Bianco / White / белый

APPLICAZIONI / APPLICATIONS / Применения

	GIOSTRA
	DAMA
	DAMA L
	TRIGA
	TRIGA SLIM

Mensola legno 22 / Wooden shelf 22 / полка 22

Materiale / Materials / МАТЕРИАЛ
Legno / Wood / Дерево



GIOSTRA/SWS-60		GIOSTRA/SWS-90		GIOSTRA/SWS-120	
Kg.	2.3	Kg.	3.5	Kg.	4.7
L cm	60.0	L cm	90.0	L cm	120.0
H cm	1.8	H cm	1.8	H cm	1.8
P cm	22.0	P cm	22.0	P cm	22.0

APPLICAZIONI / APPLICATIONS / Применения

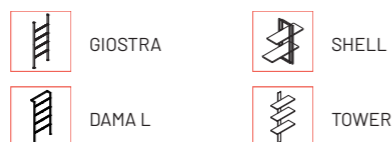

Mensola legno 31 / Wooden shelf 31 / полка 31

Materiale / Materials / МАТЕРИАЛ
Legno / Wood / Дерево



SW-60		SW-90		SW-120	
Kg.	3.3	Kg.	5.0	Kg.	6.7
L cm	60.0	L cm	90.0	L cm	120.0
H cm	1.8	H cm	1.8	H cm	1.8
P cm	31.0	P cm	31.0	P cm	31.0

APPLICAZIONI / APPLICATIONS / Применения

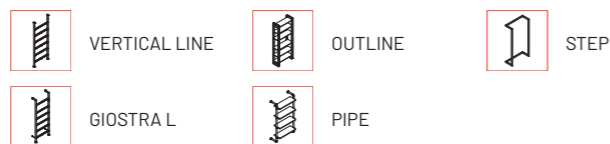

Mensola legno 50 / Wooden shelf 50 / полка 50

Materiale / Materials / МАТЕРИАЛ
Legno / Wood / Дерево



GIOSTRA/SW-60		GIOSTRA/SW-90		GIOSTRA/SW-120	
Kg.	5.4	Kg.	8.1	Kg.	10.8
L cm	60.0	L cm	90.0	L cm	120.0
H cm	1.8	H cm	1.8	H cm	1.8
P cm	50.0	P cm	50.0	P cm	50.0

APPLICAZIONI / APPLICATIONS / Применения



Pensile / Cabinet / подвесной ящик

Materiale / Materials / МАТЕРИАЛ
Legno / Wood / Дерево



PENS-60		PENS-90		PENS-120	
Kg.	1.9	Kg.	2.8	Kg.	3.8
L cm	60.0	L cm	90.0	L cm	120.0
H cm	36.0	H cm	36.0	H cm	36.0
P cm	31.0	P cm	31.0	P cm	31.0

APPLICAZIONI / APPLICATIONS / Применения

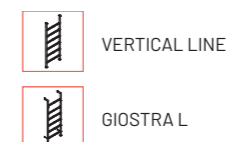

Cassettiera / Drawer / ящик

Materiale / Materials / МАТЕРИАЛ
Legno / Wood / Дерево



GIOSTRA/CA	
Kg.	18.3
L cm	90.0
H cm	20.0
P cm	50.0

APPLICAZIONI / APPLICATIONS / Применения



FINITURE / FINISHES / Покрытие

	Rovere / Wood durmast / дуб
	Denim / Denim / джинс
	Bianco / White / белый

Mensola / Shelf / полка

Materiale / Materials / МАТЕРИАЛ
Alluminio / Aluminum / Алюминий



GIOSTRA-LU/S-600

Kg.	1.9
L cm	60.0
H cm	2.0
P cm	31.0



GIOSTRA-LU/S-900

Kg.	2.8
L cm	90.0
H cm	2.0
P cm	31.0

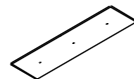

GIOSTRA-LU/S-1200

Kg.	3.8
L cm	120.0
H cm	2.0
P cm	31.0

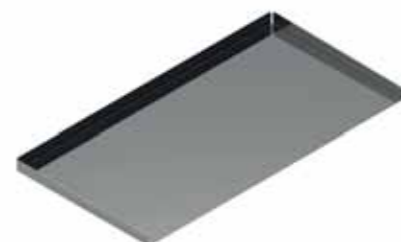

APPLICAZIONI / APPLICATIONS / Применения



VERTICAL LINE



GIOSTRA L

FINITURE / FINISHES / Покрытие

	Ghisa / Cast iron / чугун
	Titanio / Titanium / титан
	Nero / Black / черный

Pannello ragnatela / Panel / панель

Materiale / Materials / МАТЕРИАЛ
Alluminio / Aluminum / Алюминий

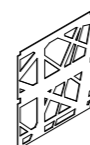

GIOSTRA/PANN

Kg.	3.4
L cm	90.3
H cm	100.0
P cm	0.65

APPLICAZIONI / APPLICATIONS / Применения



GIOSTRA

FINITURE / FINISHES / Покрытие

	Ghisa / Cast iron / чугун
	Titanio / Titanium / титан
	Nero / Black / черный

Sacchetti contenitori / Container bags / контейнеры

Materiale / Materials / МАТЕРИАЛ
Cellulosa / Cellulose / Целлюлоза



SCH/S

Kg.	0.1
L cm	8.0
H cm	10.0
P cm	5.5



SCH/M

Kg.	0.2
L cm	14.0
H cm	16.0
P cm	9.5



SCH/L

Kg.	0.3
L cm	40.0
H cm	30.0
P cm	20.0



APPLICAZIONI / APPLICATIONS / Применения



GIOSTRA



DAMAL L



TRIGA SLIM



DAMA



TRIGA

FINITURE / FINISHES / Покрытие

	Grigio / Gray / коричневый
	Marrone / Brown / серый

Ceppo porta coltelli / knife block / держатель для ножей

Materiale / Materials / МАТЕРИАЛ
Legno / Wood / Дерево

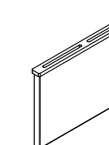

TAGLIERE

Kg.	0.6
L cm	31.0
H cm	21.0
P cm	1.8

APPLICAZIONI / APPLICATIONS / Применения



HORIZON

FINITURE / FINISHES / Покрытие

	Legno faggio / Beech wood
--	---------------------------



Portarotolo bagno / Roll holder / держатель для бумажного полотенца

Materiale / Materials / МАТЕРИАЛ
Alluminio / Aluminum / Алюминий

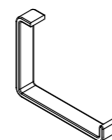
**HB-PR**

Kg.	0.1
L cm	2.0
H cm	12.0
P cm	9.5

Portarotolo / Roll holder / держатель для бумажного полотенца

Materiale / Materials / МАТЕРИАЛ
Alluminio / Aluminum / Алюминий

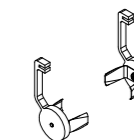
**HORIZON/PR**

Kg.	0.087
L cm	VAR
H cm	11.9
P cm	5.9

Porta dispenser / Soap dispenser holder / держатель для жидкого мыла

Materiale / Materials / МАТЕРИАЛ
Alluminio / Aluminum / Алюминий

**HB-PD**

Kg.	0.1
L cm	7.4
H cm	21.8
P cm	11.5

Gancio / Hook / крючок

Materiale / Materials / МАТЕРИАЛ
Alluminio / Aluminum / Алюминий

**HORIZON/H****HB/H**

Kg.	0.1	Kg.	0.1
L cm	1.0	L cm	2.0
H cm	6.8	H cm	10.0
P cm	2.0	P cm	2.0

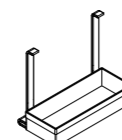

Porta spugne / Sponge holder / держатель для мочалок и мыла

Materiale / Materials / МАТЕРИАЛ
Alluminio / Aluminum / Алюминий

**HB-PS**

Kg.	0.75
L cm	30.0
H cm	19.0
P cm	12.0

FINITURE / FINISHES / Покрытие

-  Anodizzato spazzolato / Brushed anodized / шлифованное анодирование
-  Ghisa / Cast iron / чугун

APPLICAZIONI / APPLICATIONS / Применения

-  HORIZON
-  HORIZON BIG

NORMATIVE

I colori sono puramente indicativi poiché dipendenti dalla qualità della stampa.

I componenti elettrici gestiti presso il nostro magazzino rispettano tutti gli standard di qualità e le normative vigenti.

Damiano Latini declina ogni responsabilità per eventuali errori o inesattezze e si riserva di modificare senza preavviso le caratteristiche dei prodotti illustrati.

Sono tassativamente vietate le riproduzioni per fini commerciali di immagini e disegni tecnici senza specifica autorizzazione da parte di Damiano Latini srl.

Per ulteriori informazioni visitate il sito www.damianolatini.it
Catalogo aggiornato a Gennaio 2020.

REGULATIONS

Colours are purely indicative as they depend on the print quality.

All electrical components operated at our warehouse are compliant with quality standards and regulations in force.

Damiano Latini refuses any responsibility for any errors or inaccuracies and reserves the right to modify without notice features of all displayed products.

Any kind of reproduction of images and technical drawings for commercial purposes are strictly forbidden unless expressly authorised by Damiano Latini srl.

For more information visit our web site www.damianolatini.it
Catalogue updated to January 2020.

НОРМАТИВНЫЕ ТРЕБОВАНИЯ

Указанные цвета являются строго идициативными, поскольку зависят от качеств печати. Все электрические компоненты, которые администрируются на нашем складе, отвечают всем стандартам качества и действующим нормам.

Дамиано Латини уклоняется от всякой ответственности за все ошибки или неточности, и сохраняет за собой право без предупреждения менять характеристики проиллюстрированных товаров. Категорически запрещено использовать в коммерческих целях фотографии и технические рисунки без авторизации со стороны Дамиано Латини.

За дополнительной информацией по продуктам, пожалуйста, посетите наш сайт: www.damianolatini.it

Каталог обновлен в Январь 2020.



DAMIANO LATINI
Via Sandro Pertini, 63812
Montegranaro (FM) Italy
T +39 0734 894144
info@damianolatini.it
www.damianolatini.it

SOCIAL



Damiano Latini S.r.l.
Via Sandro Pertini, 63812
Montegranaro (FM) Italy
T +39 0734 894144 - F +39 0734 894152
info@damianolatini.it - www.damianolatini.it

Capezzuoli Rappresentanze s.n.c.
Strada Prov. le 1 per S. Gimignano - Loc. Fosci n. 9
53036 Poggibonsi (SI)
Tel. 0577 992129
capezzuoli@libero.it - info@capezzuoli.com
www.capezzuoli.com